



Quanzhou: Quanzhou Sangchuan Electric Equipment Co., Ltd
Tel: +86-595-2898 3300 Fax: +86-595-2898 3388
Address: 3# Zixin Road, Jiangnan Hi-Tech Industrial Park, Quanzhou,
Fujian, China

Shanghai: Shanghai Sanch Electric Technology Co., Ltd
Add: 7th Floor, No. 393, 1555 Lane, Jinshajiang West Road, Jiading District,
Shanghai
Tel: +86-21-6951 5275 Fax: +86-21-6951 5175

Introduction Manual For S900 Series Inverters

Contents

PREFACE -----	1
I . SAFETY INSTRUCTIONS -----	2
1.NOTES FOR OPERATION-----	2
2.NOTES FOR OPERATION ENVIRONMENT-----	4
II. DESCRIPTIONS FOR BODY AND INSTALLATION -----	5
1.OPERATION ENVIRONMENT-----	5
2.MODEL DESCRIPTION-----	6
3.SPECIFICATIONS-----	7
4.LIST OF APPLICABLE NO FUSE BRAKER-----	9
5.APPLICATION AND DESCRIPTION FOR AMBIENT EQUIPMENTS-----	10
6.BASIC WIRING DIAGRAM-----	13
7.EXTERNAL DIMENSIONS-----	15
III. DESCRIPTION OF OPERATION PANEL -----	16
1.DESCRPTION FOR DIGITAL OPERATION PANEL-----	16
2.DESCRPTION OF PANEL OPERATION-----	18
3.PRELIMINARY OPERATION-NOT CONNECTING WITH MOTOR-----	19
IV. LIST OF DESCRIPTIONS FOR FUNCTIONAL PARAMETERS -----	21
V. DESCRIPTION OF FUNCTIONAL PARAMETERS -----	32
0.USER'S PARAMETERS-----	32
1.BASIC PARAMETERS-----	35
2.OPERATION MODE PARAMETERS-----	39
3.OUTPUT FUNCTION PARAMETERS-----	43
4.INPUT FUNCTION PARAMETERS-----	48
5.MULTI-STEP SPEED AND PATTERN OPERATION PARAMETERS-----	54
6.PROTECTION PARAMETERS-----	55
7.SPECIAL PARAMETERS-----	59
8.HIGH FUNCTION PARAMETERS-----	60
9.COMMUNICATIONS PARAMETERS-----	63
A.WOBBLE FREQUENCY FUNCTION PARAMETERS-----	73
VI. TROUBLE SHOOTING -----	76
1.ALARM AND CORRECTIVE MEASURES-----	76
2.TROUBLESHOOTING FOR ALARMS IN GENERAL-----	78
VII. MAINTENANCE AND AMBIENT ELEMENTS -----	79

PREFACE

Thanks for your use of SANCH inverter! This instruction manual, which includes operation descriptions and notes for maintenance, shall be delivered to the end-user.

For safety running and effective operation, this instruction manual shall be read thoroughly prior to use, which shall also be preserved for later use.

Provided problems occur and solution is not provided in this instruction manual, contact your SANCH Electric representative or contact with our company directly. Our professional technicians will serve for you actively. And please continue to adopt products of SANCH, give valuable opinion and advice.

1. Reading Instructions

Symbols of " DANGER" and" ATTENTION" in the manual indicates that, for safety running or maintenance of inverters or other electrical products, attention shall be attached during delivering, installation, operation and checks for the inverter. And these notes shall be applied for a better and safer operation.



WARNING indicates a potentially hazardous situation visiting. If not used correctly, personnel damage even death may be caused.



CAUTION indicates a potentially hazardous situation visiting. If not used correctly, serious damage to inverter or machine may be resulted.

WARNING

- Do not touch circuit board and other components after power supply off and CHARGE indicators are still ON.
- Never connect wires while power on. Do not check components or signal for circuit board during operation.
- Do not dismantle or change inner wire, circuit or components unnecessarily. Make sure grounding terminals are correctly grounded. 200V class: GroundingIII ; 400V class: Special Grounding.

CAUTION

- Do not perform a insulation test and withstand voltage test by megohmmeter, it can cause semi-conductor components to be damaged by high voltage.
- Never connect the output terminals U, V, W to AC power supply.
- IC of CMOS on control circuit of the inverter shall be damaged by electrostatic influence. Do not touch main circuit board.

2. Products receiving

All products have been performed with strict test and inspection. After receiving the inverters, the following checks shall be performed.

- To check that SANCH inverter, an instruction manual.
- To check whether model number correspond with model and capacity your purchase order.
- To check whether there are damaged parts during transportation and delivering. If there are, do not connect with power supply.

If any of the above checkpoints are not satisfactory, contact your SANCH representative for a quick resolution.

I SAFETY INSTRUCTIONS

1. NOTES FOR OPERATION

Before wiring

CAUTION

- Specification of applying power supply shall correspond to input voltage of the inverter.

WARNING

- Main circuit terminals must be correct, L1/R, L2/ S and L3/ T are input terminals and it's forbidden to use mixing with U, V and W. Failure to observe this may cause the inverter damaged.

CAUTION

- When delivering the inverter, do not take the cover directly. Take the air fan seat to prevent the cover got off. Inverters getting off which may cause damage to personal or machine shall be avoided.
- Install the inverter on metal or other non-inflammable materials. Do not fix it on inflammable materials which may cause a fire hazard.
- In case of several inverters are installed together in one control panel, a fan shall be prepared to make sure temperature lower than 40°C, thus overheating or a fire hazard shall be avoided.
- Make sure applied power supply comply with label showed on the right of the machine. Failure to observe this may cause action failure.

During operation

WARNING

- Never put in or take off the motor during operation, otherwise over-current even over burning the main circuit of the inverter may happen.
- When auto-restart function is set, do not approach the machine since motor can be reset suddenly after being stopped.
- The function set can make the stop key invalid, which is different from the emergency stop key. Please pay attention to it.

CAUTION

- Never touch heat sink or discharging resistor since temperature may be very high.
- Since it is easy to change running speed from low to a high speed, verify safe working range of motor and machine before running.
- Use brake unit according to the method described in wiring diagram.
- Do not check signals during running.
- All parameters of the inverter have been preset at the factory according to line frequency. Do not change the setting value at will.

During check and maintenance

 CAUTION

- Ambient temperature for operating the inverter shall be -10°C to $+50^{\circ}\text{C}$ ($+40^{\circ}\text{C}$ parallel installation) and 90%RH no condensation. However under this condition, the ambient environment must be without drips of water or metal dust.

During rejection

 CAUTION

- Explosion may occur when burning the electrolytic capacitor of the main circuit and printing plate. Toxic gas may be generated when burning control panel and other plastic fittings. It shall be treated as Industrial waste.

2. NOTES FOR OPERATION ENVIRONMENT

DO not use the inverter in an environment with the following conditions:

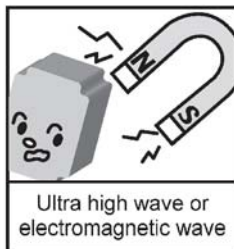
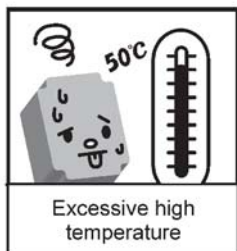
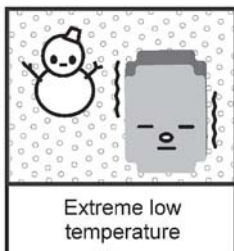
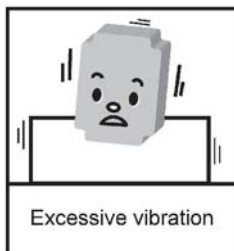
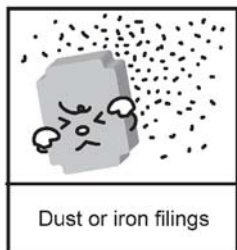
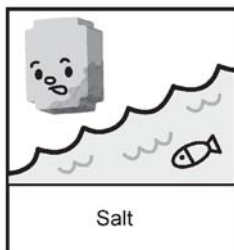
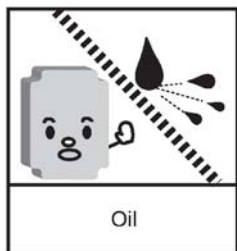
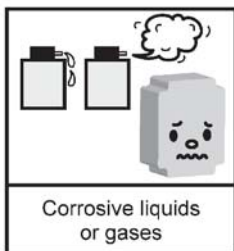
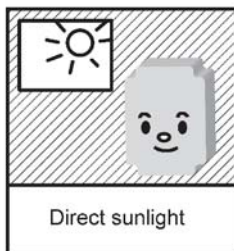

II . DESCRIPTIONS FOR BODY AND INSTALLATION

1. OPERATION ENVIRONMENT

Since operation environment can directly influence functions and operation life, to ensure proper performance and long operation, follow the recommendations below when choosing allocation for installing the inverter. Make sure it is protected from the following:

Extreme cold and heat.

Use only with the ambient temperature range: -10°C to $+50^{\circ}\text{C}$ (+ 40°C parallel installation)

Rain, moisture

Direct sunlight.(Avoid using outdoors)

Corrosion of oil sprays or salt

Corrosive fluid and methane

Dust or metallic particles in the air

Radioactive materials and inflammable materials

Electromagnetic interference (Avoid using together with welding machine or dynamic machines.)

Vibration

(If inverter must be used in this environment, an anti vibration pad is necessary).

Attention shall be attached to clearance of inverters allocated closely. A fan shall be installed to make sure temperature is lower than 50°C

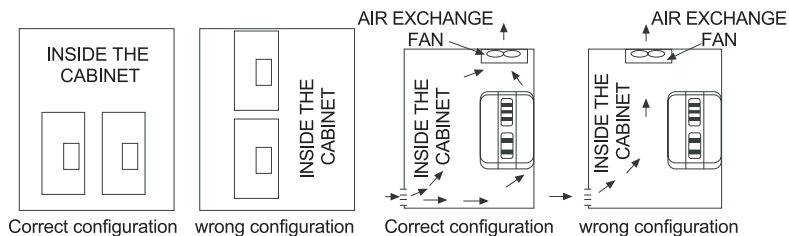

For cooling off, face shall be toward front and upper parts shall be upwards.

Clearance shall meet the following specifications:

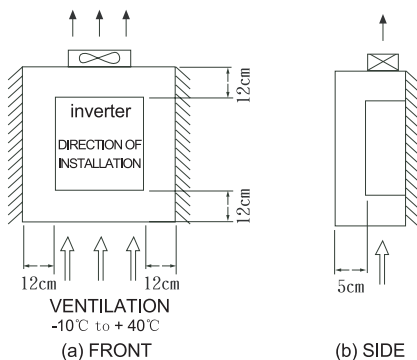

2. MODEL DESCRIPTION

- Model →
- Input power supply Spec →
- Output power supply Spec →
- Output frequency →

DRIVE MODEL: S900-4T1.5G

INPUT : AC 3 PHASE 380~460V 50/60Hz

OUTPUT : 3 PHASE 0~460V 3.2kVA 4.2A

FREQUENCY RANGE : 0.1~400Hz

SANG CHUAN ELECTRIC CO.,LTD

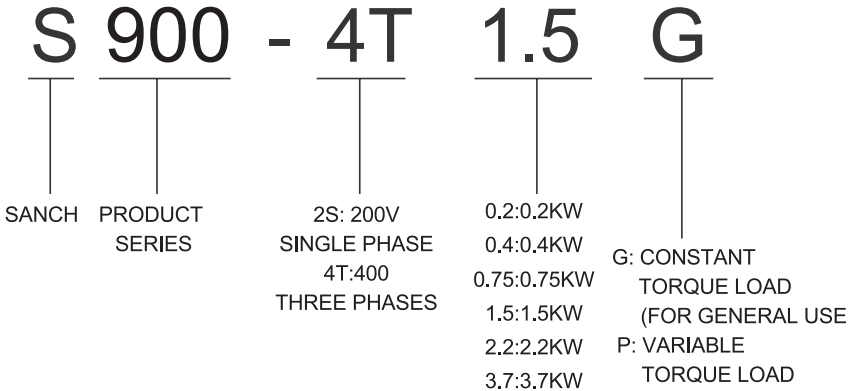

3. SPECIFICATIONS

Product Specifications

■ 200V Single Phase Series

Model number S900-2S□□□G		0.2	0.4	0.75	1.5	2.2
Output	Max applicable motor output power(kW)	0.2	0.4	0.75	1.5	2.2
	Max applicable motor output power(HP)	0.25	0.5	1	2	3
	Output rated capacity(kVA)	0.6	1.0	1.9	2.5	4.2
	Output rated current (A)	1.6	2.5	4.2	7.5	11
	Output frequency range	0.1 to 400Hz				
	Over load capacity	150% of rated output current and run for 60sec.				
	Max output voltage	Correspond to input power supply				
Input	Phase number. Voltage. Frequency	Single phase. 200 to 240V. 50/60Hz				
	Allowable variation range for Voltage. Frequency	Voltage: $\pm 10\%$, Frequency: $\pm 5\%$				
	Power capacity needed (kVA)	1.1	1.5	2.2	3.9	6.0
	Input current (A)	4.9	6.5	10	17.5	27
	Cooling System	Natural cooling		Fan cooling		

■ 400V Three Phase Series

Model number S900-4T□□□G		0.4	0.75	1.5	2.2	3.7
Output	Max applicable motor output power(kW)	0.4	0.75	1.5	2.2	3.7
	Max applicable motor output power(HP)	0.5	1	2	3	5
	Output rated capacity(kVA)	1.2	2.3	3.2	4.2	6.3
	Output rated current (A)	1.5	2.5	4.2	5.5	8.2
	Output frequency range	0.1 to 400Hz				
	Over load capacity	150% of rated output current and run for 60sec.				
	Max output voltage	Correspond to input power supply				
Input	Phase number. Voltage. Frequency	Three phase. 380 to 460V. 50/60Hz				
	Allowable variation range for Voltage. Frequency	Voltage: $\pm 10\%$, Frequency: $\pm 5\%$				
	Power capacity needed (kVA)	1.3	2.3	4.0	4.8	6.0
	Input current (A)	1.9	3.5	6.0	7.2	9.0
	Cooling System	Natural cooling		Fan cooling		

Standard Specifications

Controlling Characteristics	Control mode		Adopting SVPWM or SPWM modulating techniques
	Output frequency range		0.1 to 400Hz
	Frequency setting analyzing degree		0.1Hz
	Output frequency analyzing degree		0.1Hz
	PWM load wave frequency		Available to modulate from 2 to 12kHz.
	Torque increase		Auto slip compensation, at 5Hz the starting torque can reach 150% of rated torque.
	Jump frequency		3 points can be set from 0.1 to 400Hz
	Acceleration/deceleration time		0.1 to 600 seconds. (2 steps of accel/decel time can be set separately.)
	DC braking		Available to be operated from 0.1 to 60.0Hz from STOP, braking current 0 to 100% of the rated current. Starting time 0 to 60.0 sec. Stopping time 0 to 60.0 sec.
V/f curve		V/f curve available to be set	
Operation Characteristics	Frequency setting signal	Digital operation panel	Set by UP and DOWN keys
		External signal	Potentiometer 5k Ω , 0 to 10VDC, 4 to 20mA DC, multi-function input choosing 3 to 5 (7 velocities: jog-on, up/down command), serial communications (RS-485)
	Running operating signal	Digital operation panel	Available to be operated by 【RUN】 , 【STOP】 keys.
		External terminals	2 wire style (Fwd/Stop, Rev/Stop, Run/Stop and Fwd/Rev)/ 3 wire operation, JOG running, Serial communications Port(RS-485)
	Custom Input Terminal		Switching of 7 step pre-set available speed; Switching of First/Second acceleration/deceleration time; prohibiting acceleration/deceleration and external interrupt input; Jog running UP/DOWN frequency terminal setting; Count terminals
	Custom Output Terminal		During running, frequency arrival output, non-zero count agreement output, over torque output, external interrupt reference, low voltage detection, operation mode reference, fault output and external fault interruption.
	Analog signal output		Corresponding to output current, output frequency 1(before slip ratio compensation), output frequency 2(after slip ratio compensation), output voltage, consumed power, DC bus voltage
Built in Function			Setting max/min output frequency; momentary power off restarting; fault restarting; setting of S curve acceleration/deceleration time; auto-voltage stabilizing output modulation; digital frequency output signal; fault records; parameters locking; reset to factory setting; inhibiting reverse run; over voltage stalling prevention, electronic thermal relay.
Protection Function			Over current; over voltage; low voltage; external fault interruption input; motor over load; over load of the drive and drive overheating
Digital operation panel			Consisting of 6 functional keys, 7 step LED in 4 digits; 4 status LED indicators. Available to set frequency, display actual output frequency, output current, self-determined unit parameter overview of users, modify settings and for parameter locking, fault displaying. Available to perform running, stop, reset, fwd/rev run
Environment	Operational Environment temperature		-10℃ to +50℃ (+40℃ parallel installation, no condensation, no freezing)
	Storing temperature		-20℃ to +60℃
	Operational Environment dampness		Below 90%RH without moister
	Installation height		Lower than 1000m, without corrosive gas, fluid and dust.
	Vibration		Under 20Hz 9.80665m/s ² (1g), 20 to 50Hz: 5.88 m/s ² (0.6g)
	Protection level		IP20

SANCH Electric shall not be responsible for faults due to the following:

(1) Absence or inapplicable or over large non-fuse breakers was put between the power supply and the inverter, which results in the inverter fault.

(2) Magnetic contactors or advance capacitor or Surge Absorber were connected in series between the inverter and motor.

- A three phase squirrel-cage induction motor which corresponds with the capacity of the inverter shall be adopted.
- If more than one motors were driven simultaneously by one inverter, the current of these motors when running shall below capacity of the inverter. And each motor shall be prepared with a thermal relay in appropriate capacity.
- Phase advance capacitors and other capacity elements such as LC or RC shall not be fixed between the inverter and motor.

4. LIST OF APPLICABLE NO-FUSE BREAKER

The wire size recommended to main circuit terminals is to use single-stranded HIV wire (max. allowable temperature 75°C) under ambient temperature of 40°C. The content in () is the example of single-stranded IV wire (max. allowable temperature 60°C).

Type S900-2S single-phase series	Nominal applied motor (kW)	Rated current of breaker (A)	Main circuit (mm ²)				Control circuit (mm ²)
			Input wire	Positive and negative bus	Output wire	Grounding wire	Control terminal wire
S900-2S0.2G	0.2	10	1	1	1	2	1
S900-2S0.4G	0.4	15	1.5	1	1	2	1
S900-2S0.75G	0.75	20	2.5	1	1	2	1
S900-2S1.5G	1.5	40	4	1.5	2.5	2	1
S900-2S2.2G	2.2	50	5.5	1.5	2.5	2	1

Type S900-4T three-phase series	Nominal applied motor (kW)	Rated current of breaker (A)	Main circuit (mm ²)				Control circuit (mm ²)
			Input wire	Positive and negative bus	Output wire	Grounding wire	Control terminal wire
S900-4T0.4G	0.4	5	1	1	1	2	1
S900-4T0.75G	0.75	10	1	1	1	2	1
S900-4T1.5G	1.5	15	1.5	1	1.5	2	1
S900-4T2.2G	2.2	15	1.5	1.5	1.5	2	1
S900-4T3.7G	3.7	20	2.5	1.5	2.5	2	1

5. APPLICATION AND DESCRIPTION FOR AMBIENT EQUIPMENTS



Power supply:

- Make sure voltage class is correct, otherwise inverter may be damaged.
- A no fuse breaker (air circuit breaker) shall be provided between AC supply and inverter.

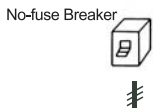

No-fuse Breaker

- Circuit breaker which complies with rated voltage and current of inverter shall be applied as ON/OFF control for inverter. And it shall also be protective to the inverter.
- Never use circuit breaker as ON/OFF switch for inverter.

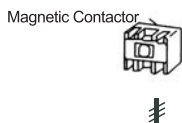

Leakage Breaker

- A leakage breaker shall be installed to prevent mal-functioning and to ensure the safety of operators; to prevent the mal-functions, those of which the sensitivity current above 200mA and action time above 0.1 sec shall be applied.

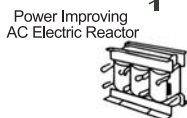

Magnetic Contactor

- Inverters can be used without a magnetic contactor (MC) installed at the power supply side. However, when used for external control or automatically restart after power off, or when braking control is used, a magnetic contactor shall be applied.
- Do not use the magnetic contactor as RUN/STOP switch for inverter.

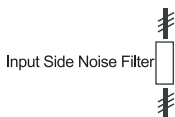

Power Improving AC Electric Reactor

- When the output capacity is greater than 500kVA or enter-wire electricity capacity acts, the instant jump of voltage or current will be produced, resulting to damage the internal circuit. So it is recommended that an AC electric reactor is installed additionally to improve function factors and decrease the power harmonic. The wiring distance is within 10m.

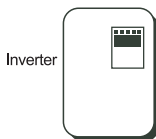

Input side radio interference suppression filter

- The Input side radio interference suppression filter must be applied if inverter has electronic induction load around.



Inverter:

- Input Power supply terminals L1/R, L2/S and T/L3 can be connected without phase sequence.
- Connect output terminals U, V and W to U, V and W of motors, if the inverter is in forward run reference, while motor reverse runs, change any two of U, V and W
- Never connect U, V, W to AC Power supply otherwise inverter may be damaged.
- Grounding terminals shall be grounded correctly. Category III Grounding: below 100 Ω ;Special grounding: below 10 Ω .

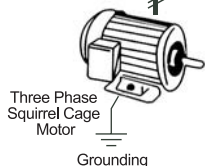

Grounding

Zero radio interference suppression filter

- If specialized radio interference suppression filters are fit at inverter output side, radiation interference and induction interference shall be decreased.

Wiring shall be checked whether correct or not. Peripheral wiring shall fulfill the following requirements.

(Do not use a buzzer of control circuit to check wiring)

(A) Wiring for control circuit Power supply must be isolated or far from other high voltage wirings or high current power lines, thus electromagnetic interference can be avoided.

See diagrams below:

● Individual power supply bridge for inverter

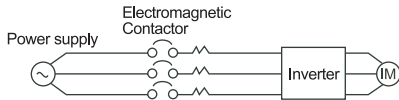

● If inverter power supply circuit is used commonly with other machines, inverter-specialized noise filter or isolating transformer shall be added.

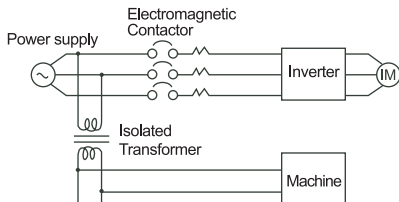
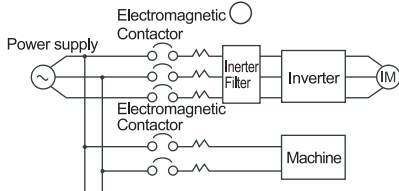

● Good effect may not be received if general use anti-interference filters are applied

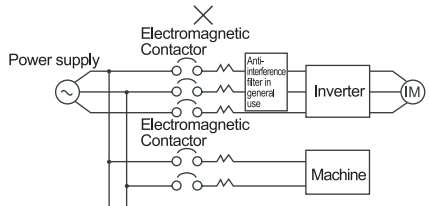
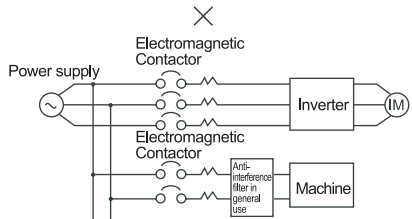

● Interference during transmission can be prohibited by adding an inverter-specialized radio interference suppression filter at main circuit output side. For preventing electromagnetic radiation, a metal tube shall be installed, and distance from signal wiring of other control machines shall be 30cm at least.

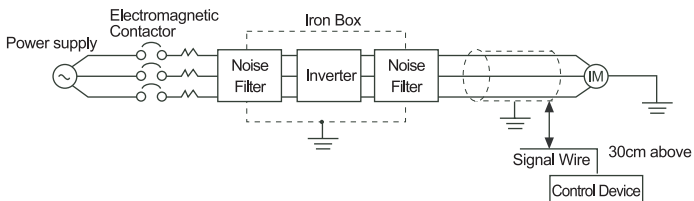

- Voltage drop of wiring shall be considered providing that inverter and motor are with an excessive distance. Voltage drop (V) = $\sqrt{3} \times$ wiring resistance (Ω /km) \times wire length (m) \times current(A) $\times 10^{-3}$, load wave frequency shall be modified according to wiring prepared.

Distance between inverter and motor wiring	Below 50m	Below 100m	Above 100m
Allowable load wave no.	Below 12kHz	Below 9kHz	Below 6kHz
Set value for parameter 2-09	12	9	6

(B) Wiring for control circuit shall be isolated or far from main circuit wiring or other high voltage/current power lines, thus electromagnetic interference shall be avoided.

- For preventing inductive interference and malfunction, shielded twisted pair shall be used for control circuit. Shielding layer shall connect grounding terminals.

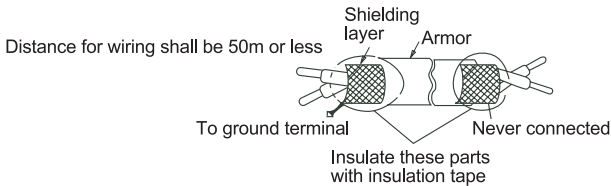

(C) Grounding terminal for inverters shall be grounded properly. Below 100 Ω : Category III Grounding;
Below 10 Ω : Special grounding

- AWG shall be taken as standard for ground wire. Ground wire shall be as short as possible.
- Never ground simultaneously for Inverter ground wire with other large current load (such as welding machine or large power motors). They shall be grounded separately.
- Ground circuit shall be avoided when several inverters are grounded simultaneously.

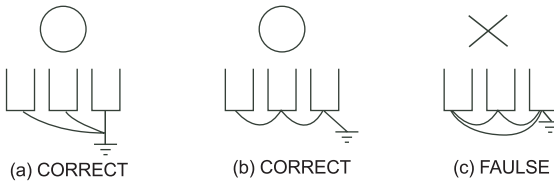

(D) Cable line width for main circuit and control circuit shall be selected according to power line standard.

(E) After completing of grounding and wiring, check for the following items: wiring is proper; wire is not broken and screws are securely tightened.

6. BASIC WIRING DIAGRAM

Wiring of AC motor drive can be divided into two parts, the main circuit and control circuit. Users must connect terminals as diagram shows.

The following diagram is the standard wiring diagram of S900 series AC motor driver.

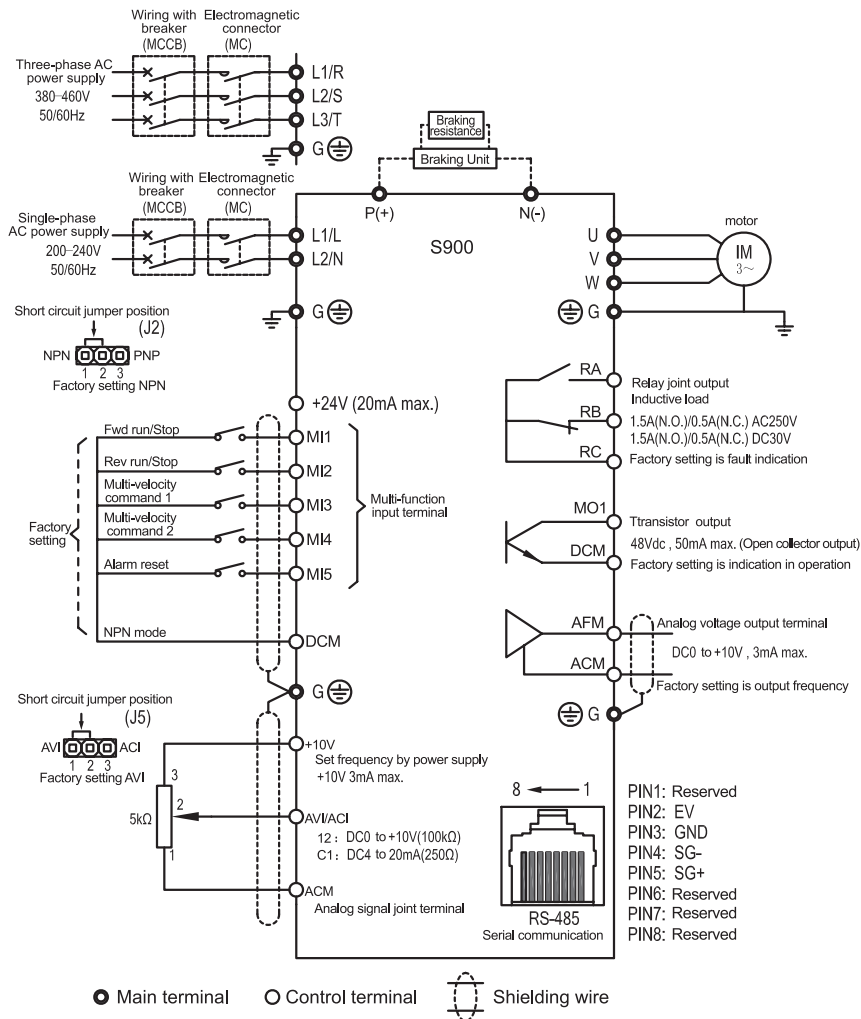

Note: RS-485 may damage the terminal of connector side. So the terminal configuration has to be confirmed before connection. The used signal wire can be cut if necessarily.

Description for S900 Series Inverter Terminals

Main circuit terminal descriptions

Terminal symbols	Function
L1/R,L2/S,L3/T	Main circuit AC power supply input(For single phase input, connect to L1/L and L2/N)
U/T1,V/T2,W/T3	Connect to motor
P(+),N(-)	Connect to braking module
 G	For grounding(High voltage wave impact and noise interference shall be avoided.)

Terminal Symbol Description

Terminal symbols	Function of Terminal	Specification
RA-RC	Multifunctional reference signal output contactor	See Description 3-05 for RELAY CONTACTOR
RB-RC	Multifunctional reference signal output contactor	
MI1-DCM	Fwd run/Stop	See Description 4-04-4-08
MI2-DCM	Rev run/Stop	
MI3-DCM	Multifunctional input option 1	
MI4-DCM	Multifunctional input option 2	
MI5-DCM	Alarm reset	
MO1-DCM	Multifunctional output terminal	See description of 3-09 (Open collector output)
+10V-ACM	Power supply for speed setting	Speed reference power supply (+10V)
AVI/ACI-ACM	Analog voltage frequency reference	(0 to +10V/4~20mA) Max output frequency
AFM-ACM	Analog frequency/ current meter	0 to +10VDC, Max +11V/output frequency
RS-485 serial communications	Serial connected communications board	RS-485 Serial connected communications connector
+24V-DCM	Assisted control power supply	DC 20V to 26V (20mA Max)

Please use Shielded Twisted Pair to insulate the control signal wire.

Note: RS-485 may damage the terminal of connector side. So the terminal configuration has to be confirmed before connection. The used signal wire can be cut if necessarily.

7.EXTERNAL DIMENSIONS

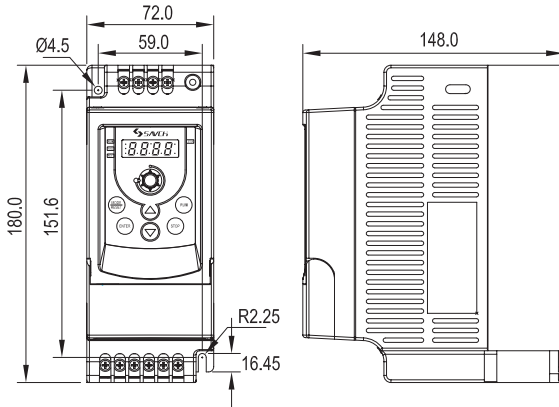

Figure 7-1 Dimension and installation size of S900-2S0.2G-0.75G / S900-4T0.4G-1.5G (unit: mm)

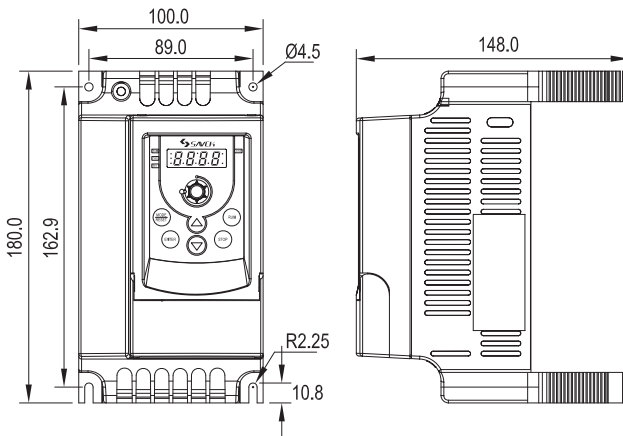
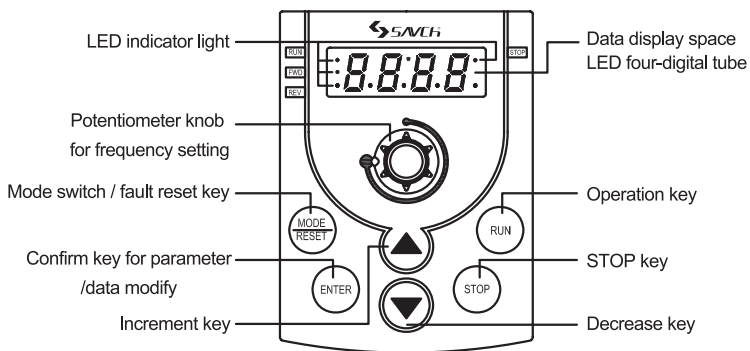

Figure 7-2 Dimension and installation size of S900-2S1.5G-2.2G / S900-4T2.2G-3.7G (unit: mm)

III. DESCRIPTION OF OPERATION PANEL

1. DESCRIPTION FOR DIGITAL OPERATION PANEL

The digital operation panel has two spaces: display space and operating space. Parameters setting and different operation states shall be displayed on the display space, while for the operating space, it is an interface for communications of the operators and inverter.



KEY FUNCTION DESCRIPTION



MODE/RESET:

In normal operation mode, various states information of the AC motor drive, such as frequency reference and input current, shall be displayed by depressing this key; in various operative modes of the parameter setting, the machine shall reset by depressing this key; Press this key to reset the error when error occurs



ENTER:

After selecting appropriate operation or program mode, i.e. parameters must be replaced (This key shall be available regardless the AC motor drive is in operation or stop), program mode shall be realized by depressing this key; as an ENTER key for parameter setting, if this key is depressed in program mode, modified parameters shall be taken into memory by the system.



RUN:

To start operation (Pressing this key is invalid when set as external terminal control)



STOP:

To stop operation



UP/DOWN:

For modifying data or parameter programs

If depressing this key for long time, for a short time then released, all modified parameters shall be alternated step by step;

If depressed it for a long time and not released, all modified parameters shall alternate quickly.

Description of indicator light

RUN Operation indicator light: it will light on when the inverter is in operation state.

STOP Stop indicator light: it will light on when the inverter is in stop state.









FWD Forward indicator light: it will light on when the rotating direction of inverter is forward.

REV Reverse indicator light: it will light on when the rotating direction of inverter is reversal.

Note: In the following several states, indicator lights are combined to indicate the inverter state.

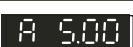
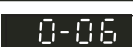
- Set the inverter to operate, RUN indicator light is on and STOP flickers when the output frequency is 0.
- Set the inverter to stop, RUN indicator light flickers and STOP is on when the output frequency hasn't decreased to 0.
- If it is necessary to set the inverter to do the reverse operation when it is in forward operation state, stop the forward operation first, then start the reverse operation. The FWD indicator light flickers and REV is on before the forward rotating stops.
- If it is necessary to set the inverter to do the forward operation when it is in reverse operation state, stop the reverse operation first, then start the forward operation. The FWD indicator light is on and REV flickers before the reverse rotating stops.

Descriptions of Functional Displaying Project

Display Project	Description
	Showing the current set frequency of inverter.
	Displaying actual frequency output from inverter to motor
	Displaying physical quantity(U) defined by users (U=H*0.05)
	Displaying count value(C) of internal counter
	Displaying output current of U, V and W at output side of the inverter
	Displaying parameter project. Content of this parameter shall be displayed by depressing ENTER .
	Displaying parameter content value. Modified materials shall be stored by depressing. ENTER
	If END information (as diagram left shows) lasts for about 1 sec, it means that data has been received and memorized automatically. If data needs modifying, it shall be completed by acting directly with UP / DOWN and depress ENTER key again.
	This interface will be displayed when setting parameters are not received.

2. DESCRIPTION OF PANEL OPERATION

Scenes Selection

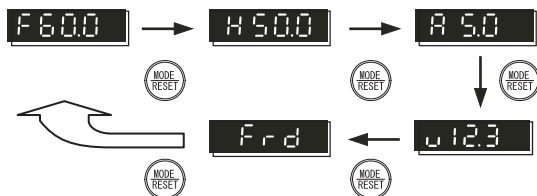

Configuration Setup



Data Modification

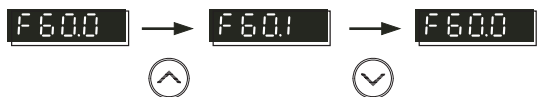

Steering Setup

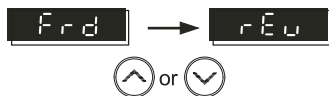

3. PRELIMINARY OPERATION-NOT CONNECTING WITH MOTOR

- Prior to connecting power supply with inverter, check and make sure that AC power supply voltage is within input voltage range of the inverter.
- Connect power supply to L1/R,L2/S and L3/T input terminals of the inverter.
- Operation mode control selection

The operation mode can be divided into the following categories:

operation command is controlled by panel.

(2-03=d0) (Factory setting)

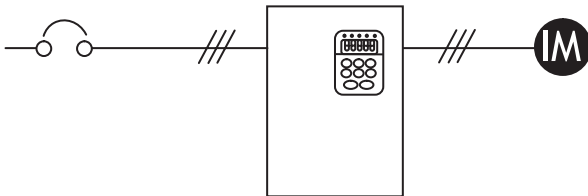

Operation command is controlled by external terminals, STOP key on panel is valid.

Two line operation control, "FWD/STOP" and "REV/STOP"

(2-03=d1, 4-04=d1)

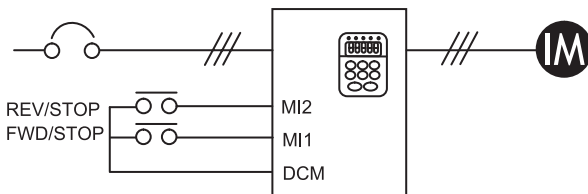

Operation command is controlled by external terminals, STOP key on panel is valid.

Two line operation control, "FWD / REV" and "OPERATION/STOP" control configuration.

(2-03=d1, 4-04=d2)

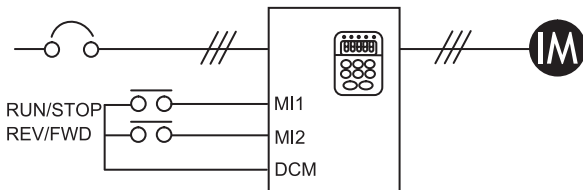

- 3-wire operation control mode Configuration 1
(2-03=d1, 4-04=d3)

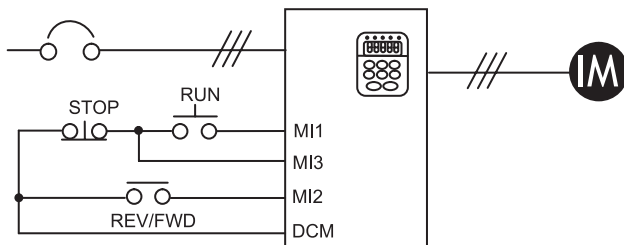

- 3-wire operation control mode Configuration 2
(2-03=d1, 4-04=d4)

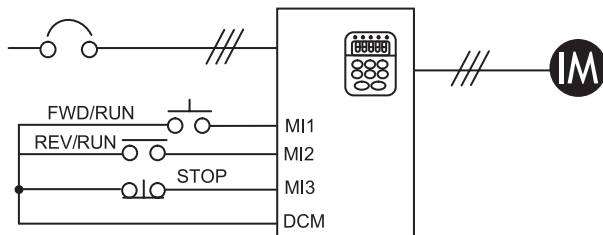

- Operation command is controlled by communications
(2-03=d3/d4 [STOP key valid/invalid])

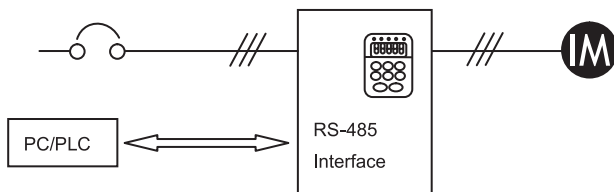

IV. LIST OF DESCRIPTIONS FOR FUNCTIONAL PARAMETERS

0.USER'S PARAMETERS		⚡ Set during running available				
Parameter	Parameter functions	Setting range	Factory setting			
0-00	Inverter type code recognition (Only for Reading)	1:200V/0.2kW	Factory setting			
		2:200V/0.4kW				
		3:200V/0.75kW				
		4:200V/1.5kW				
		5:200V/2.2kW				
		6 to 9:Reserved				
		10:400V/0.4kW				
		11:400V/0.75kW				
		12:400V/1.5kW				
		13:400V/2.2kW				
		14:400V/3.7kW				
		0-01		Rated current display of Inverter (Only for Reading)	200V/0.2kW:1.6 A	Factory setting
					200V/0.4kW:2.5 A	
					200V/0.75kW:4.2A	
200V/1.5kW:7.5A						
200V/2.2kW:11.0A						
400V/0.4kW:1.5A						
400V/0.75kW:2.5A						
400V/1.5kW:4.2A						
400V/2.2kW:5.5A						
400V/3.7kW:8.2A						
0-02	Data initialization	0 to 9,11 to 20: No function	0			
		10:Parameter reset to factory setting				
⚡ 0-03	Machine on display Selection	0:F(Display set frequency reference)	0			
		1:H(Display actual running frequency)				
		2:U(Display multi-function determination)				
		3:A(Display motor running current)				
⚡ 0-04	Determining multifunctional display	0:Displaying output physical quantity (u) defined by operators	0			
		1:Displaying count value (c)				
		2:Displaying program operation content(X=tt)				
		3:Displaying DC-BUS voltage(U)				
		4:Displaying output voltage (E)				
		5:Displaying rotating speed (r)				
		6:Output frequency 2 (after slip compensation) (h)				
		7:Input power (P)				
8 to 15:Reserved						
⚡ 0-05	Proportional constant setting	0.1 to 160	1.0			
0-06	Software version	Only for reading	###			
0-07	Input parameter password protection	0 to 999	0			
⚡ 0-08	Setting parameter password protection	0 to 999	0			
0-09	Reserved					

Parameters marked with "reserved" will be displayed, but will not be used for the inverter. Please do not change the code of such kind of parameter.

1.BASIC PARAMETERS			⚡ Set during running available	
Parameter	Parameter functions	Setting range		Factory setting
1-00	Maximum frequency	5.0 to 400Hz		50.0
1-01	Base frequency	10.0 to 400Hz		50.0
1-02	Rated voltage at base frequency	200V:2.0 to 255V		220
		400V:2.0 to 510V		440
1-03	Intermediate frequency setting	0.1 to 400Hz		1.0
1-04	Intermediate voltage setting	200V:2.0 to 255V		12.0
		400V: 2.0 to 510V		24.0
1-05	Starting frequency	0.1 to 60.0Hz		1.0
1-06	Output voltage at starting frequency	200V:2.0 to 255V		12.0
		400V:2.0 to 510V		24.0
1-07	Frequency limiter(Upper)	1 to 110%		100
1-08	Frequency limiter(Lower)	0 to 100%		0
⚡ 1-09	Acceleration time 1	0.01 to 600s		10.0
⚡ 1-10	Deceleration time 1	0.01 to 600s		10.0
⚡ 1-11	Acceleration time 2	0.01 to 600s		10.0
⚡ 1-12	Deceleration time 2	0.01 to 600s		10.0
⚡ 1-13	Acceleration time (JOG)	0.01 to 600s		10.0
⚡ 1-14	Deceleration time (JOG)	0.01 to 600s		10.0
⚡ 1-15	JOG frequency setting	1.0 to 400Hz		6.0
1-16	Reserved			
1-17	Reserved			
1-18	Reserved			
1-19	V/f curve setting	0 to 6		0

Parameters marked with "reserved" will be displayed, but will not be used for the inverter. Please do not change the code of such kind of parameter.

2.OPERATION MODE PARAMETERS			⚡ Set during running available	
Parameter	Parameter functions	Setting range		Factory setting
2-00	Frequency command 1	0:Keys on keypad		3
		1:Input DC 0 to 10V by external terminals AV1		
		2:Input DC 4 to 20mA by external terminals AC1		
		3:Controlled by VR on keypad		
		4:Operated by RS-485 communications interface		
		5:Operated by RS-485 communications interface(Frequency memory)		
		6:Controlled by UP/DOWN		
		7:Controlled by UP/DOWN (Frequency memory)		
		8:Reserved		

2.OPERATION MODE PARAMETERS
 **Set during running available**

Parameter	Parameter functions	Setting range	Factory setting
2-01	Frequency command 2	0: Keys on keypad	0
		1:Input DC 0 to 10V by external terminals AVI	
		2:Input 4 to 20mA by external terminals ACI	
		3:Controlled by VR on keypad panel	
		4:Reserved	
		5:Reserved	
		6:Controlled by UP/DOWN	
		7:Controlled by UP/DOWN (Frequency memory)	
2-02	Combination way of frequency sources	0:Frequency command 1	0
		1:Frequency command 1 + Frequency command 2	
		2:Frequency command 1 - Frequency command 2	
2-03	Operation method	0:Operated by keypad	0
		1:Operated by external terminals. STOP on keypad available	
		2:Operated by external terminals. STOP on keypad unavailable	
		3:Operated by Communications Interface RS-485. STOP on keypad available	
		4:Operated by Communications Interface RS-485. STOP on keypad unavailable	
2-04	Deceleration mode	0:Normal deceleration	0
		1:Coast to stop	
2-05	Reserved		
2-06	External fault (EF) stop mode	0:Reserved	1
		1:External fault (EF) coast to stop	
2-07	Reference loss detection (Terminal AVI) (Stop mode)	0:Deceleration stop	2
		1:Coast to stop	
		2:Holding operation command after deceleration stop	
2-08	Reserved		
2-09	Motor sound (Carrier frequency)	2.0 to 12.0kHz	6.0
2-10	Rotation direction limitation	0:Fwd/Rev run available	0
		1:Rev run inhibited	
		2:Fwd run inhibited	
2-11	Reference loss detection (Terminal ACI) (Stop mode)	0:Non-processing	0
		1:Coast to stop	
		2:EF display after deceleration stop	
		3:Continuous operation by reference frequency before disconnection	
2-12	Power on start	0:Operation available	0
		1:Operation unavailable	
2-13to2-14	Reserved		

Parameters marked with "reserved" will be displayed, but will not be used for the inverter. Please do not change the code of such kind of parameters.

Notes:

- 1) In 2-00 and 2-01, when 2-00 has been set as d1(AVI) or d2(ACI), 2-01 can't be set as d1 or d2 again.
- 2) In 2-00 and 2-01, when 2-00 has been set as d6 or d7 (controlled by UP/DOWN), 2-01 can't be set as d6 or d7 again.
- 3) The parameter of 2-07 is valid only when the frequency is given by analog input AVI and input set 0. If the frequency is given by AVI, but press the STOP key, the inverter will stop still according to the mode of 2-04.

3.OUTPUT FUNCTION PARAMETERS				↗ Set during running available
Parameter	Parameter functions	Setting range	Factory setting	
3-00	Frequency detection (Level)	1.0 to 400Hz	1.0	
3-01	Count value agreement setting	0 to 999	0	
3-02	Appointed count agreement setting	0 to 999	0	
3-03	Fwd run reference delay setting	0.0 to 60.0s	0.0	
3-04	Rev run reference delay setting	0.0 to 60.0s	0.0	
3-05	Terminal [RA/RB/RC] Function (Relay output) Normally Open Contactor (RA-RC) Normally Closed Contactor (RB-RC)	0:No function	8	
		1:Inverter running		
		2:Frequency arrival		
		3:Zero speed		
		4:Over-torque detection		
		5:During external alarm		
		6:Low voltage detection		
		7:External terminal running mode		
		8:Alarm output(for any alarm)		
		9:Frequency detection		
		10:During pattern operation		
		11:Pattern operation one cycle completion		
		12:Pattern operation completion		
		13:Pattern operation pause		
		14:Terminal count value arrival		
		15:Terminal designated count value arrival		
		16:Inverter ready to run		
		17:Fwd running		
		18:Rev running		
19:Fwd/ Rev running direction				
3-06	Analog output setting	0:Output frequency 1 (before slip compensation)	0	
		1:Output frequency 2 (after slip compensation)		
		2:Analog current meter(0 to 250% of rated current)		
		3:Analog output voltage		
		4:Analog DC bus voltage		
		5:Input power		
3-07	Reserved			
↗ 3-08	Analog output gain selection	1 to 200%	100	

3.OUTPUT FUNCTION PARAMETERS

⚡ Set during running available

Parameter	Parameter functions	Setting range	Factory setting
3-09	Terminal [MO1] Function	0:No function	1
		1:Inverter running	
		2:Frequency arrival	
		3:Zero speed	
		4:Over-torque detection	
		5:During external alarm	
		6:Low voltage detection	
		7:External terminal running mode	
		8:Alarm output(for any alarm)	
		9:Frequency detection	
		10:During pattern operation	
		11:Pattern operation one cycle completion	
		12:Pattern operation completion	
		13:Pattern operation pause	
		14:Terminal count value arrival	
		15:Terminal designated count value arrival	
		16:Inverter ready to run	
		17:Fwd running	
		18:Rev running	
19:Fwd/ Rev running direction			
3-10	Reserved		
3-11	Dead time setting of Fwd and Rev changeover	0.0 to 600 s	0.0
3-12	Cooling fan control	0:Fan continuous running	0
		1:Run for 1 minute after pressing stop key	
		2:Operate/stop along with inverter	
⚡ 3-13	Bias [AVI](Bias base point)	0.0 to 10.0V	0.0
⚡ 3-14	Bias [AVI](Bias value)	0.0 to 100% of Maximum Frequency	0.0
⚡ 3-15	Analog input Adjustment for [AVI] (Gain base point)	0.0 to 10.0V	10.0
⚡ 3-16	Analog input Adjustment for [AVI] (Gain)	0.0 to 100% of Maximum Frequency	100
⚡ 3-17	Bias [ACI](Bias base point)	0.0 to 20.0mA	4.0
⚡ 3-18	Bias [ACI](Bias value)	0.0 to 100% of Maximum Frequency	0.0
⚡ 3-19	Analog input Adjustment for [ACI] (Gain base point)	0.0 to 20.0mA	20.0
⚡ 3-20	Analog input Adjustment for [ACI] (Gain)	0.0 to 100% of Maximum Frequency	100
3-21	Reserved		
3-22	Reserved		

Parameters marked with "reserved" will be displayed, but will not be used for the inverter. Please do not change the code of such kind of parameters.

4.INPUT FUNCTION PARAMETERS
↗ Set during running available

Parameter	Parameter functions	Setting range	Factory setting
↗ 4-00	[VR] Input frequency bias setting	0.0 to 350Hz	0.0
↗ 4-01	[VR] Input frequency bias adjustment direction	0:Positive direction 1:Negative direction	0
↗ 4-02	[VR] Input frequency gain setting	1 to 200%	100
4-03	[VR] Negative bias operation setting	0:No negative bias	0
		1:Reversible negative bias	
		2:Not reversible negative bias	
4-04	Terminal [MI1] function (Setting range from d0 to d31)*	0:No function	1
		1:MI1: forward run/stop, MI2: reverse run/stop	
		2:MI1: run/stop, MI2: fwd/rev run	
		3:3-wire operation control(1): MI1 run, MI2 fwd/rev run, MI3 STOP(Normally closed)	
4-05	Terminal [MI2] function (Setting range d0, d5 to d31)	4:3-wire operation control(2): MI1 run (Triggering), MI2 run(Triggering), MI3 STOP(Normally closed)	0
		5:External fault(EF), normally open interface input (N.O)	
		6:External fault(EF) normally closed interface input (N.C)	
		7:RESET alarm	
4-06	Terminal [MI3] function (Setting range d0, d5 to d31)	8>Select multi-frequency (0 to 1 steps)	8
		9>Select multi-frequency (0 to 3 steps)	
		10>Select multi-frequency (0 to 7 steps)	
		11:Reserved	
4-07	Terminal [MI4] function (Setting range d0, d5 to d31)	12>Select frequency command 2/1	9
		13:Accel /Decel inhibition command	
		14>Select 1 ST and 2 nd Accel/Decel time	
		15:External alarm, normally open (NO) input	
4-08	Terminal [MI5] function (Setting range d0, d5 to d31)	16:External alarm, normally closed(NC) input	7
		17:Up command	
		18:Down command	
		19:Pattern operation command	
		20:Pattern operation pause command	
		21:JOG frequency reference	
		22:Count reset	
		23:Reserved	
		24:JOG-FWD	
		25:JOG-REV	
		26:Reserved	
		27:Wobble frequency function input	
		28:Wobble frequency state reset	
29:Inhibiting output (N.O)			
30:Inhibiting output (N.C)			
31:Counter trigger signal input			

4.INPUT FUNCTION PARAMETERS				⚡ Set during running available
Parameter	Parameter functions	Setting range	Factory setting	
4-09	Speed tracking after external alarm reset	0:Tracking downwards from speed before external alarm	0	
		1:Tracking upwards from min speed		
4-10 to 4-22		Reserved		

Parameters marked with "reserved" will be displayed, but will not be used for the inverter. Please do not change the code of such kind of parameters.

Notes: When 4-04 is set as d1 to d2, function set by MI2 is invalid. When 4-04 is set as d3 to d4, function set by MI2 and MI3 is invalid.

5.MULTI-STEP SPEED AND PATTERN OPERATION PARAMETERS				⚡ Set during running available
Parameter	Parameter functions	Setting range	Factory setting	
⚡ 5-00	Multi frequency 1	0.0 to 400Hz	0.0	
⚡ 5-01	Multi frequency 2	0.0 to 400Hz	0.0	
⚡ 5-02	Multi frequency 3	0.0 to 400Hz	0.0	
⚡ 5-03	Multi frequency 4	0.0 to 400Hz	0.0	
⚡ 5-04	Multi frequency 5	0.0 to 400Hz	0.0	
⚡ 5-05	Multi frequency 6	0.0 to 400Hz	0.0	
⚡ 5-06	Multi frequency 7	0.0 to 400Hz	0.0	
5-07 to 5-14		Reserved		
5-15	Pattern Operation (Mode)	0:Pattern operation inactive	0	
		1:Active(Stop after operating for 1 cycle)		
		2:Active (Pattern operation performs in cycles until stop command input)		
		3:Active (Stop after operating for 1 cycle) (with stop intervals).		
5-16		Pattern Operation (Rotating Direction)	0 to 255(0: Forward Run 1: Reverse Run)	0
5-17		Reserved		
5-18	(Step 0 Time)	0 to 65500s	0	
5-19	(Step 1 Time)	0 to 65500s	0	
5-20	(Step 2 Time)	0 to 65500s	0	
5-21	(Step 3 Time)	0 to 65500s	0	
5-22	(Step 4 Time)	0 to 65500s	0	
5-23	(Step 5 Time)	0 to 65500s	0	
5-24	(Step 6 Time)	0 to 65500s	0	
5-25	(Step 7 Time)	0 to 65500s	0	
5-26 to 5-33		Reserved		

Parameters marked with "reserved" will be displayed, but will not be used for the inverter. Please do not change the code of such kind of parameters.

6.PROTECTION PARAMETERS
↗ Set during running available

Parameter	Parameter functions	Setting range	Factory setting
6-00	Over voltage stall prevention function	0:Inactive	370 740
		200V series:340-400V 400V series:680-800V	
6-01	Over current stall prevention Level setting	0:Inactive	170
		20 to 200%	
6-02	Over-torque detection (Mode selection)	0:No detection	0
		1:Over torque detection (OL2) during constant speed running, continue to run after detection.	
		2:Over torque detection (OL2) during constant speed running, stop running after detection.	
		3:Over torque detection (OL2) during acceleration, continue to run after detection.	
		4:Over torque detection (OL2) during acceleration, stop running after detection.	
6-03	Over-torque detection (Detection level)	30 to 200%	150
6-04	Over-torque detection time	0.1 to 10.0s	0.1
6-05	Electronic thermal overload protection for Motor (Select motor characteristics)	0:Inactive	0
		1:Active(For a general-purpose motor with shaft -driven cooling fan)	
		2:Active(For a motor with separately powered cooling fan)	
6-06	Electronic thermal overload protection for Motor (Thermal time constant)	30 to 600s	60
6-07	Alarm history (Latest)	0:No alarm records	0
6-08	Alarm history (1 st last)	1:OC(Over current)	0
6-09	Alarm history (2 nd last)	2:OV(Over voltage)	0
6-10	Alarm history (3 rd last)	3:OH(Over heating)	0
6-11	Alarm history (4 th last)	4:OL(Inverter overload)	0
6-12	Alarm history (5 th last)	5:OL1(Motor overload)	0
		6:EF(External fault)	
		16:CF2 (Read error of internal storage IC data)	
		17:External alarm signal input	
		18:oL2 (Motor overload)	
		22:CF3.1 (Internal temperature is over high or circuit fault at power-on test)	
		23:CF3.2 (Over voltage of internal DC voltage side at power-on test)	
		24:CF3.3 (Under voltage of internal DC voltage side at power-on test)	
		29:HPF.1 (Over voltage protection circuit fault)	
		31:HPF.3 (Over current protection circuit fault)	
37:Errb (Wobble frequency setting error)			







7.MOTOR PARAMETER		⚡ Set during running available		
Parameter	Parameter functions	Setting range		Factory setting
⚡ 7-00	Motor(Rated current)	30 to 120%		85
⚡ 7-01	Motor(No load current)	0 to 90%		30
7-02	Auto torque compensation setting	0.0 to 30.0		0.0
⚡ 7-03	Auto slip compensation setting	0.0 to 10.0		0.0
7-04 to 7-10	Reserved			
7-11	Motor(Rated speed)	500 to 3000min ⁻¹		1450
7-12	Motor(Pole number)	0 to 30pole		4
⚡ 7-13	Motor(Rated frequency)	5.0 to 400Hz		50.0
7-14 to 7-74	Reserved			

Parameters marked with "reserved" will be displayed, but will not be used for the inverter. Please do not change the code of such kind of parameters.

8.HIGH FUNCTION PARAMETERS		⚡ Set during running available		
Parameter	Parameter functions	Setting range		Factory setting
8-00	DC braking(Braking level)	0.0 to 100%		0.0
8-01	DC braking(Braking time at starting)	0.0 to 60.0s		0.0
8-02	DC braking(Braking time at stopping)	0.0 to 60.0s		0.0
8-03	DC braking(Braking starting frequency)	0.1 to 60.0Hz		1.0
8-04	Restart after momentary power failure (Mode selection)	0:Inactive(Trip immediately)		0
		1:Active(Restart at the frequency at which the power failure occurred, for general loads)		
		2:Active(Restart at the starting frequency, for light inertia loads)		
8-05	(Max allowable time for power failure)	0.3 to 5.0s		2.0
8-06	(Restart time)	0.3 to 5.0s		0.5
8-07	(Max current setting for speed tracking)	30 to 200%		150
8-08	Jump Frequency1(Upper)	0.0 to 400Hz		0.0
8-09	Jump Frequency1(Lower)	0.0 to 400Hz		0.0
8-10	Jump Frequency2(Upper)	0.0 to 400Hz		0.0
8-11	Jump Frequency2(Lower)	0.0 to 400Hz		0.0
8-12	Jump Frequency3(Upper)	0.0 to 400Hz		0.0
8-13	Jump Frequency3(Lower)	0.0 to 400Hz		0.0
8-14	Auto-reset(Times)	0 to 10		0
8-15	AVR function selection	0:AVR function available		1
		1:AVR function unavailable		
		2:AVR function cancelled during deceleration		
8-16 to 8-18	Reserved			
⚡ 8-19	Reserved			
8-20	Auto-reset(Counter clear time)	1 to 100 min		10
8-21	Reserved			
8-22	Auto-reset(Reset interval)	0.1 to 20.0s		2.0

Parameters marked with "reserved" will be displayed, but will not be used for the inverter. Please do not change the code of such kind of parameters.

9.COMMUNICATIONS PARAMETERS
 Set during running available

Parameter	Parameter functions	Setting range	Factory setting
 9-00	RS-485 Communications (Station address)	1 to 247	1
 9-01	(Baud rate)	0:Baud rate 4800 bps 1:Baud rate 9600 2:Baud rate 14400 3:Baud rate 19200 4:Baud rate 38400	1
 9-02	(Communications error processing)	0:Warning and running continuously 1:Warning and deceleration to stop 2:Warning and coasting to a stop 3:No warning and running continuously	0
 9-03	(No-response error detection time)	0:Not detected 1 to 20s	0
 9-04	(Communications format) <Data length, Parity, STOP bit>	0:ASCII mode <8, N,1> 1:ASCII mode <8, N,2> 2:ASCII mode <8, E,1> 3:ASCII mode <8, E,2> 4:ASCII mode <8, O,1> 5:ASCII mode <8, O,2> 6:RTU mode <8, N,2> 7:RTU mode <8, E,1> 8:RTU mode <8, O,1> 9 to 11:Reserved	0
9-05	Reserved		
9-06	Reserved		
 9-07	(Response interval)	0 to 200 (one unit=2ms)	1

Parameters marked with "reserved" will be displayed, but will not be used for the inverter. Please do not change the code of such kind of parameters.

A.WOBBLE FREQUENCY FUNCTION PARAMETERS
 Set during running available

Parameter	Parameter functions	Setting range	Factory setting
A-00	Wobble frequency selection	0:Not applying	0
		1:Applying	
A-01	Wobble frequency input mode	0:Set according to wobble frequency action delay	0
		1:Controlled by external terminals.	
A-02	Pre-set frequency of wobble Frequency	0.0 to 400Hz	0.0
A-03	Action delay setting of preset wobble frequency	0.0 to 600s	0.0
A-04	Central frequency of wobble frequency	0:According to operation frequency source	0
		1:According to fixed frequency setting(A-05)	
A-05	Fixed central frequency setting of wobble frequency (Max frequency base)	0.01 to 100%	20.0
A-06	Reference source setting for wobble aptitude	0:Centering frequency base	0
		1:Max frequency(1-00) base	
A-07	Wobble aptitude width setting	0.0 to 50.0%	0.0
A-08	Wobble frequency hopping (relative aptitude)	0.0 to 50.0%	0.0
A-09	Wobble frequency cycle	0.1 to 655s	10.0
A-10	Triangle wave rising time (Relative cycle)	0.1 to 99.9%	50.0
A-11	Wobble frequency machine stop starting mode	0:Starting in memorizing state before stop	0
		1:Restarting	
A-12	Wobble state power loss memory	0:Memorizing	0
		1:Non-memorizing	

V. DESCRIPTION OF FUNCTIONAL PARAMETERS

All the functional parameters are described in detail in this chapter. According to attributes, the parameters can be divided into 11 groups; in most of the applications, presetting for operation shall be completed by performing with these parameters of groups.

The 11 groups of parameters are listed as below:

0: User's Parameters

1: Basic Parameters

2: Operation Mode Parameters

3: Output Function Parameters

4: Input Function Parameters

5: Multi-step and Pattern Operation Parameters

6: Protection Parameters

7: Motor Parameters

8: High Function Parameters

9: Communications Parameters

A : Wobble Frequency Function Parameters

***** indicates that for 400V class, value shall be 2 times of setting.

⚡ indicates that it's available to be set during running.

Parameters marked with "reserved" will be displayed, but will not be used for the inverter. Please do not change the code of such kind of parameters.

0. USER'S PARAMETERS

0-00	Inverter type code recognition (only for reading)	Factory setting	d #
	Setting range	Non	

Inverter type code shall be read through this parameter, and for capacity of the drive, which has been set at factory, please see diagram below. Also, it shall be applied to judge whether current in parameter (0-01) corresponds with rated current of the specific machine. Parameter 0-00 corresponds with 0-01 as the diagram below indicates.

200V(type code)	d1	d2	d3	d4	d5
Power kW	0.2	0.4	0.75	1.5	2.2
Horsepower HP	0.25	0.5	1	2	3
Rated current 0-01(A)	1.6	2.5	4.2	7.5	11.0

400V(type code)	d10	d11	d12	d13	d14
Power kW	0.4	0.75	1.5	2.2	3.7
Horsepower HP	0.5	1	2	3	5
Rated current 0-01(A)	1.5	2.5	4.2	5.5	8.2

0-01	Rated current display of inverter (only for reading)	Factory setting	d #.#
	Setting range	Non	

This parameter displays the rated current of inverter, corresponding to machine types displayed at Parameter 0-00.

0-02	Data initialization	Factory setting	d 0
	Setting range	d 0<->20	No action
		d 10	All parameters reset to factory setting

This parameter enable users to reset all parameters to factory setting.

0-03	Machine on display selection	↗	Factory setting	d 0
	Setting range	d 0	F(Displaying set frequency reference)	
		d 1	H(Displaying actual running frequency)	
		d 2	U(Displaying multifunctional definitions)	
		d 3	A(Displaying motor running current)	

This parameter enables users to determine the machine ON display by themselves.

0-04	Determining multifunctional display	↗	Factory setting	d 0
	Setting range	d 0	Displaying output physical quantity(u)defined by operators	
		d 1	Displaying count value (c)	
		d 2	Displaying program operation content (X=tt)	
		d 3	Displaying DC-BUS voltage(U)	
		d 4	Displaying output voltage (E)	
		d 5	Displaying rotating speed(r)	
		d 6	Output frequency 2 (after slip compensation) (h)	
		d 7	Input power (P)	
	d 8<->d 15	Reserved		

Output physical quantity defined by users shall be displayed when it is set to d0 (Physical quantity =H×0-05)

0-05	Proportional constant setting	↗	Factory setting	d 1.0
	Setting range	d 0.1<->d 160	Unit	0.1

Proportional constant K, the constant used in output physical quantity defined by users. This parameter should be used in conjunction with d0, d5 and d6 of 0-04.

The display value shall be counted as this formula shown below:

When set 0-04 as d0, display value= Output frequency (before slip compensation) x K (0-05)

When set 0-04 as 5d, display value= rotating speed x K (0-05).

When set 0-04 as d6, display value= Output frequency 2 (after slip compensation) x K (0-05).

0-06	Software version	Factory setting	#.#
	Setting range	Non	

Software version is only for reading.

0-07	Input parameters password protection	Factory setting	d 0
	Setting range	d 0<->d 999	
		d 0	No code locking or correct code has been input
		d 1<->999	Parameters have been locked

When this parameter indicates as d1, all parameters have been locked. Correct password must be entered to make this parameter able to write. This parameter will display d0 after entering the correct password. It will be locked again if incorrect password is entered.

After having entered the correct password, all parameters can be set before this interruption of power supply. However, if the value of 0-08 isn't cleared, which means the password protection function hasn't been cancelled, the correct password must be entered again to modify parameters when power on next time. "End" will be displayed whether the parameter password is entered correctly or not, otherwise "Err" will be displayed.

This password has three times of entering limit to prevent from entering password arbitrarily. If enter wrong password three times continuously, "Err" will be displayed. It is necessary to reboot the power supply to enter password again.

0-08	Set parameter password protection	 Factory setting	d 0
	Setting range	d 0<->d 999	
		d 0	Code not set
		d 1<->999	Code set

This parameter is set to d0 when no code was set. All parameters shall be locked so that they can only be read, but not modified, if it is set to numbers other than 0. When this parameter is d1, modification of parameter will be displayed "Err". Decode the parameter through 0-07 to reset the new password.

0-09	Reserved
-------------	----------

1. BASIC PARAMETERS

1-00	Maximum frequency	Factory setting	d 50.0
	Setting range	Unit	0.1Hz
			d 5.0<->d 400Hz

To set max output frequency of the inverter. Range of this frequency is corresponded to digital operation keypad frequency and all the other analog input frequency setting signals (0 to +10V, 4 to 20mA).

1-01	Base frequency	Factory setting	d 50.0
	Setting range	Unit	0.1Hz
			d 10.0<->d 400Hz

This setting value must be in accordance with the rated frequency on the motor nameplate.

1-02	Rated voltage at base frequency	Factory setting	d 220*
	Setting range	Unit	0.1V
			d 2.0<->d 255V*

It is used to set max output voltage of the inverter. This setting shall be in accordance with rated motor voltage explained on the nameplate.

1-03	Intermediate frequency setting	Factory setting	d 1.0
	Setting range	Unit	0.1Hz
			d 0.1<->d 400Hz

This parameter shall be used to set intermediate frequency for a random V/f curve. V/f ratio of Min frequency to Intermediate frequency shall be determined by this setting.

1-04	Intermediate voltage setting	Factory setting	d 12.0*
	Setting range	Unit	0.1V
			d 2.0<->d 255V*

This parameter shall be used to set intermediate voltage for a random V/f curve. V/f ratio of Min output voltage to Intermediate voltage shall be determined by this setting.

1-05	Starting frequency	Factory setting	d 1.0
	Setting range	Unit	0.1Hz
			d 0.1<->d 60.0Hz

For setting Min output frequency of inverter.

1-06	Output voltage at starting frequency	Factory setting	d 12.0*
	Setting range	Unit	0.1V
			d 2.0<->d 255V*

For setting Min output voltage of AC motor drive.

Setting of 1-01 to 1-06 shall be input only if the following requirements be met: 1-02 \geq 1-04 \geq 1-06; 1-01 \geq 1-03 \geq 1-05, and according to different voltage classes, voltage of 1-02, 1-04 and 1-06 shall display corresponding voltage values.

1-07	Frequency limiter (Upper)	Factory setting	d 100
	Setting range	d 1<->d 110%	Unit
			1%

1-08	Frequency limiter (Lower)	Factory setting	d 0
	Setting range	d 5.0<->d 400Hz	Unit
			1%

The % value of the above two parameters shall take Parameter 1-00 for reference.

The min as well as max values are mainly set to prevent mishandling of operators, thus protecting motor from overheating caused by over-low running frequency, or mechanical wearing by an over-high speed.

If max output frequency is set to 80%, and frequency set to (1-00) 60Hz, then max output frequency shall be 48Hz. If min output frequency is set to 10%, while Min operation frequency (1-05) set to 1.5Hz, it shall run in 6Hz in case of set frequency is below 6Hz.

1-09	Acceleration time 1	↗	Factory setting	d 10.0
1-10	Deceleration time 1	↘	Factory setting	d 10.0
1-11	Acceleration time 2	↗	Factory setting	d 10.0
1-12	Deceleration time 2	↘	Factory setting	d 10.0
	Setting range	d 0.01<->d 600s	Unit	0.01s

The acceleration time during inverter acceleration and deceleration shall be the time used for accelerating from 0Hz to Max output frequency(1-00); while deceleration time refers to the time for deceleration from Max output frequency (1-00)to 0Hz.

Applying the 2nd accel/decel time shall be available after the multi-functional terminals are set to switching of 1st and 2nd accel/decel. 2nd accel/ shall be performed when terminals for this function are closed.

As the diagram shows below, the motor adopts area of max output frequency (1-00) from 0Hz for acceleration and deceleration calculation, If 1-00 is 60.0Hz. Provided that min frequency is 1.0Hz, time for accelerating to 60Hz shall be 9.83sec, and deceleration to stop shall also be 9.83sec.

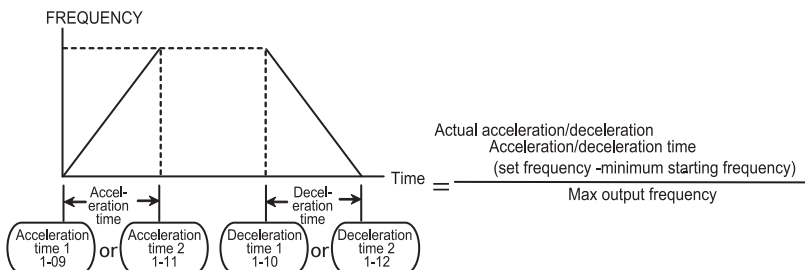

1-13	Acceleration time (JOG)	↗	Factory setting	d 10.0
	Setting range	d 0.01<->d 600s	Unit	0.01s
1-14	Deceleration time (JOG)	↗	Factory setting	d 10.0
	Setting range	d 0.01<->d 600s	Unit	0.01s
1-15	JOG frequency setting	↗	Factory setting	d 6.0
	Setting range	d 1.0<->d 400Hz	Unit	0.01Hz

Multi-functional input terminal (one from FWD, REV, X1 to X3) shall be set as jog operation when jog function is used. If switches connected with JOG function are CLOSED, inverter shall accelerate from min operation frequency (1-05) to jog operation frequency (1-15). Accel/decel time of jog run is determined with reference time set by parameter (1-13/1-14). Jog run reference also can be performed while inverter is in operation. The inverter will return to the original operation frequency after canceling the jog-on command. But other operation commands can't be performed in jog operation.

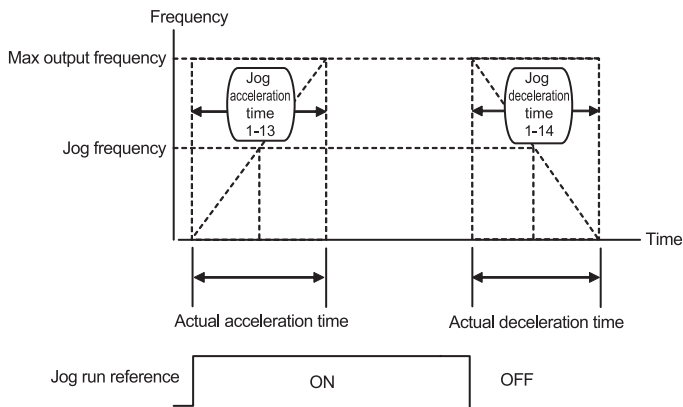

1-16 Reserved

1-17 Reserved

1-18 Reserved

1-19	V/f curve setting		Factory setting	d 0
	Setting range	d 0<->d 6	Unit	1

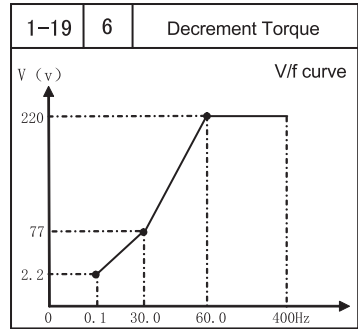
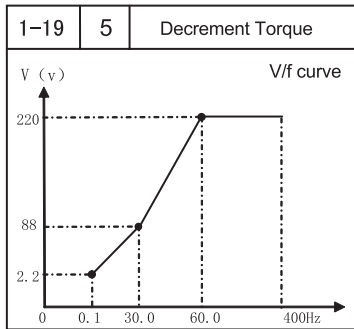
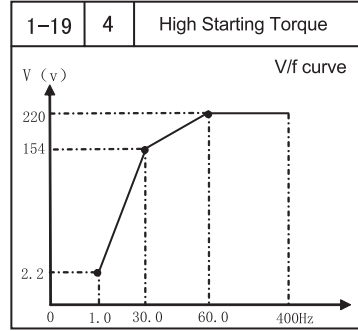
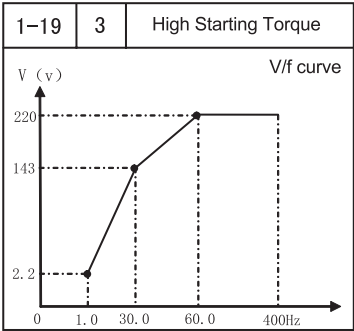
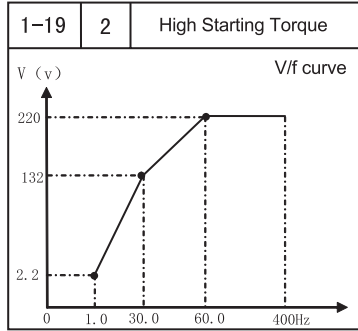
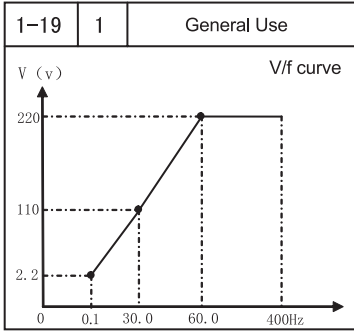

Notes: For 400V Class inverters, the voltage corresponding to frequency indicating on the V/f curve shall be 2 times of this voltage.

2. OPERATION MODE PARAMETERS

2-00	Frequency command 1		Factory setting	d 3
Setting range	d 0	Keys on keypad		
	d 1	Input DC 0 to 10V by external terminals AVI		
	d 2	Input DC 4 to 20mA by external terminals ACI		
	d 3	Controlled by VR on keypad		
	d 4	Operated by RS-485 communications interface		
	d 5	Operated by RS-485 communications interface(Frequency memory)		
	d 6	Controlled by UP/DOWN		
	d 7	Controlled by UP/DOWN (Frequency memory)		
	d 8	Reserved		

This parameter can set the frequency source of the inverter;

When the setting of frequency source uses outside analog quantity input, it may switch the voltage AVI input (DC 0 to +10V) or current ACI input (4 to 20mA) according to the jumper cap J5, whose diagram is as follows:

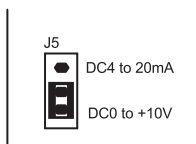

2-01	Frequency command 2		Factory setting	d 0
Setting range	d 0	Keys on keypad		
	d 1	Input DC 0 to 10V by external terminals AVI		
	d 2	Input DC 4 to 20Ma by external terminals ACI		
	d 3	Controlled by VR on keypad		
	d 4	Reserved		
	d 5	Reserved		
	d 6	Controlled by UP/DOWN		
	d 7	Controlled by UP/DOWN (Frequency memory)		
	d 8	Reserved		

This parameter set the source of the auxiliary frequency. Refer to the master frequency source setting of 2-00.

When 2-00 has been set as 1 (AVI) or 2 (ACI), 2-01 can't be set like that again.

When 2-00 has been set as d6 or d7 (controlled by UP/DOWN), 2-01 can't be set as d6 again.

2-02	Combination way of frequency sources		Factory setting	d 0
Setting range	d 0	Frequency command 1		
	d 1	Frequency command 1 + Frequency command 2		
	d 2	Frequency command 1 - Frequency command 2		

This parameter is used for the compound mode of master/auxiliary frequency. When it is set to d1, the additive frequency is set no more than the max operation frequency(1-00); when it is set to d2, it is set to the absolute value that the Frequency command 1 minus the Frequency command 2.

2-03	Operation method		Factory setting	d 0
	Setting range	d 0	Operated by keypad	
		d 1	Operated by external terminals. STOP on keypad available	
		d 2	Operated by external terminals. STOP on keypad unavailable	
		d 3	Operated by Communications Interface RS-485. STOP on keypad available	
		d 4	Operated by Communications Interface RS-485. STOP on keypad unavailable	

For external operation source reference, apart from parameter 2-03 shall be set, others see detailed descriptions in Parameter Group 4.

2-04	Deceleration mode		Factory setting	d 0
	Setting range	d 0	Normal deceleration	
		d 1	Coast to stop	

After STOP reference received, the inverter shall control the motor to stop as parameter set.

Normal deceleration: according to deceleration time set by 1-10 or 1-12, inverter decelerate in tape speed way to min output frequency(1-05) and then machine stops.

Coast to stop: Inverter stops output immediately and motor runs freely in load inertia and then stops.

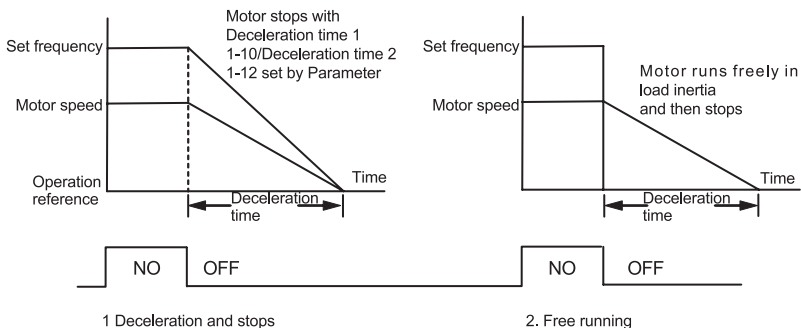

The motor stopping mode depends on the characteristics of load or machinery stopping

It's recommended to choose the mode of deceleration and stop in circumstance that, when machines stops, motor shall stop immediately to avoid individual injury or waste of materials. However, deceleration time shall be determined according to specific characteristics of machine.

While it shall be set to free running and stops, provided motor idling allowable or machine with large load flexibility, for example, air fan, pump and stirring machines.

2-05	Reserved
-------------	----------

2-06	External fault (EF) stop mode		Factory setting	d 1
	Setting range	d 0	Reserved	
		d 1	External fault (EF) coast to stop	

Description of action: When (EF) is detected by the system, a stop signal shall be sent and AC motor shall stop in the mode of this parameter.

2-07	Reference loss detection(Terminal AVI) (Stop mode)		Factory setting	d 2
	Setting range	d 0	Deceleration stop	
		d 1	Coast to stop	
		d 2	Holding operation command after deceleration stop	

Description of action: A stop signal shall be sent when frequency is set to AVI, parameter is set to d0 or d1 and system has detected that AVI set frequency is 0, AC motor drive shall coast to stop in accordance with this setting at the same time; if this parameter is set to d2 and AVI set frequency is 0, motor stops by braking, but running signals are reserved. Motor shall run continuously when AVI set frequency rise up again.

Notes: Operation key shall be unavailable when parameter is set to d0 or d1 and AVI input is 0

2-08	Reserved			
-------------	----------	--	--	--

2-09	Motor sound (Carrier frequency)		Factory setting	d 6.0
	Setting range	d 2.0<->d 12.0KHz	Unit	0.1KHz

Load frequency of PMW output shall be set by this parameter.

Load frequency	Electromagnetic noise	Noise, spill current	Radiation
2kHz	Big	Small	Small
6kHz			
12kHz	Small	Big	Big

The above form suggests that load wave frequency outputted from PWM shall influence electromagnetic noise, radiation as well as interference to the environment of motor; thus, decreasing the load wave frequency shall help the inverter to decrease temperature rise if ambient noise exceeds noise of the motor; in case of high load wave frequency, although operation noise shall be eliminated to a large degree, attention shall be paid to the interference and protection of the machine.

2-10	Rotation direction limitation		Factory setting	d 0
	Setting range	d 0	Fwd/Rev run available	
		d 1	Rev run inhibited	
		d 2	Fwd run inhibited	

If parameter is set to d1" Reverse run inhibited", REV reference of both the operation keypad and external terminals shall be unavailable. Even if Rev Run is performed currently, it shall be switched to fwd run directly. Also, provided that fwd run is inhibited, only Rev run reference shall be performed.

2-11	Reference loss detection(Terminal ACI) (Stop mode)	Factory setting	d 0
	Setting range	d 0	Non-processing
		d 1	Coast to stop
		d 2	EF display after deceleration stop
		d 3	Continuous operation by reference frequency before disconnection

Treatment to reference of 4 to 20mA (ACI) broken line is determined by this parameter. If it was set to d2 and alarm occurs, depress MODE/RESET to reset after alarm is eliminated.

2-12	Power on start	Factory setting	d 0
	Setting range	d 0	Operation available
		d 1	Operation unavailable

When operation reference is from external terminal and operation reference is always in prepared state, and when power supply of inverter is starting, this parameter is to determine operation status of motor. If it is set to d0, operation reference shall be accepted and motor begin to run; if it is set to d1, the operation reference shall be rejected and motor coast to a stop. To start the motor running, operation reference shall be firstly cancelled and then input again.

Due to mechanical vibration or switch bouncing which may be caused by switch parts fault, operation may be not inhibited although this parameter is set to 1. Thus great care shall be attached when using this function.

2-13 to 2-14	Reserved
---------------------	----------

3. OUTPUT FUNCTION PARAMETERS

3-00	Frequency detection (Level)	Factory setting	d 1.0
	Setting range d 1.0<->d 400Hz	Unit	0.1Hz

When output frequency of inverter meets a random appointed frequency value, multifunction external terminal contactor shall be "Closed" if this terminal is set to d9(3-05).

3-01	Count value agreement setting	Factory setting	d 0
	Setting range d 0<->d 999	Unit	1

This parameter set the count value of the internal counter of inverter, with one of outside terminals (M1-M15) as the trigger terminal. When the counting ends (arrives), its appointed signal output the terminal action.

3-02	Appointed count agreement setting	Factory setting	d 0
	Setting range d 0<->d 999	Unit	1

Beginning from C1, when count value reaches this parameter setting value, the multi-functional corresponding shall act. This parameter shall be applicable when count is to end. This output signal shall be used prior to machine stop, to make inverter run in low speed till motor stop.

When the counting value reaches the setting value of 3-01 from C1, give it one counting pulse again to make it return to C1 to restart counting. So the setting value of 3-02 must be less than 3-01. When the setting value of 3.2 is more than 3-01, the corresponding multifunction terminals, if any, will not act.

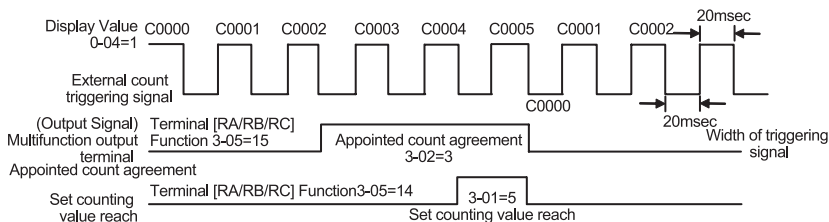

3-03	Fwd run reference delay setting	Factory setting	d 0.0
	Setting range d 0.0<->d 60.0s	Unit	0.1s

3-04	Rev run reference delay setting	Factory setting	d 0.0
	Setting range d 0.0<->d 60.0s	Unit	0.1s

Setting range d 0.0<-> d 60.0 s Unit 0.0s

When 3-05 is set as d17,d18 and d19, above two parameters match with it to use.

3-05	Terminal [RA/RB/RC] Function (Relay output) Normally Open Contactor(RA-RC) Normally Closed Contactor(RB-RC)	Factory setting	d 8
	Setting range d 0<->d 19	Unit	1

Function List

Set value	Description of function
d 0	No function
d 1	Inverter running. If output occurs to inverter, output terminal contactor which sets this parameter shall be CLOSED.
d 2	Frequency arrival. When output frequency of inverter agrees with set frequency, this contactor shall be CLOSED.
d 3	Zero speed. When inverter set frequency is less than Min starting frequency setting, this contactor shall be CLOSED.
d 4	Over-torque detection. This contactor shall be CLOSED when over-torque is detected by inverter.
d 5	During external alarm. This contactor shall be CLOSED when external alarm happens to inverter.
d 6	Low voltage detection. This contactor shall be CLOSED when input voltage over-low is detected by inverter.
d 7	External terminal running mode. This contactor shall be CLOSED when inverter reference is controlled by external terminals.
d 8	Alarm output(for any alarm). This contactor shall be CLOSED when alarm is detected by inverter.
d 9	Frequency detection. This contactor shall be CLOSED when output frequency agrees with appointed reference (3-00).
d 10	During pattern operation. This contactor shall be CLOSED when pattern operation performed.
d 11	Pattern operation one cycle completion. During pattern operation, this contactor shall be CLOSED after each running step, but it shall maintain only for 0.5sec.
d 12	Pattern operation completion. This contactor shall be CLOSED after completion of pattern operation, but it shall maintain only for 0.5sec.
d 13	Pattern operation pause. This contactor shall be CLOSED when external pause pattern operation is in action during program auto running.
d 14	Terminal count value arrival. This contactor shall be CLOSED when count value is equivalent with set value of Parameter 3-01.
d 15	Terminal designated count value arrival. This contactor shall be CLOSED when count value is equivalent with set value of Parameter 3-02.
d 16	Inverter ready to run. This contactor shall be CLOSED if no alarm was detected after motor drive power is supplied.
d 17	Fwd running. When inverter is in fwd run, delay reference time shall be in accordance with setting in Parameter 3-03, and contactor shall be CLOSED when time met. Relay shall be interrupted when inverter stops or is switched to Rev run stations. Attention shall be paid that counting here shall begin from Fwd run.
d 18	Rev running. When inverter is in Rev run, delay reference time shall be in accordance with setting in Parameter 3-04, and contactor shall be CLOSED when time met. Relay shall be interrupted when inverter stops or is switched to Fwd run stations. Attention shall be paid that counting here shall begin from Rev run.
d 19	Fwd/ Rev running direction. This reference shall be available at switching of Fwd/Rev run. Description of action: During direction switching of motor drive, the relay shall be Opened and then delayed in a time complied with setting in 3-03 and 3-04. After delay, the relay shall be closed. Provided that delay setting in 3-03 and 3-04 is 0, relay shall be kept in closed condition and not open until machine stop signal appears.

Notes:

- "CLOSED" mentioned above refers to closing of normally open contactor(RA-RC), and normally closed contactor(RB-RC) shall open simultaneously; while "open" shall refer to opening of normally open contactor(RA-RC), and normally closed contactor(RB-RC) shall be closed simultaneously.
- When it is set to d17, d18 and d19, once stop signal appears, relay shall be interrupted immediately. See sequence diagram below:

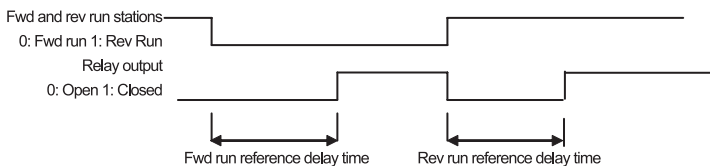

3-06	Analog output setting		Factory setting	d 0
	Setting range	d 0	Output frequency 1 (before slip compensation)	
		d 1	Output frequency 2 (after slip compensation)	
		d 2	Analog current meter(0 to 250% of rated current)	
		d 3	Analog output voltage	
		d 4	Analog DC bus voltage	
		d 5	Input power	

This parameter select inverter analog signal voltage (0 to +10VDC, up to +11V) to output the corresponding content, which is as shown in table below:

Setting value	Analog content	Max. value of output voltage corresponds to :
d 0	Output frequency 1 (before slip compensation)	Maximum frequency (1-00)
d 1	Output frequency 2 (after slip compensation)	Maximum frequency (1-00)
d 2	Analog current meter(0 to 250% of rated current)	250% rated current
d 3	Analog output voltage	200V series:250V
		400V series: 500V
d 4	Analog DC bus voltage	200V series:500V
		400V series: 1000V
d 5	Input power	200% inverter rated output

3-07	Reserved		
-------------	----------	--	--

3-08	Analog output gain selection		<input checked="" type="checkbox"/>	Factory setting	d 100
	Setting range	d 1 to d 200%		Unit	1%

This parameter adjusts voltage level of inverter analog signal output terminal FMA output to analog meter head.

3-09	Terminal [MO1] Function		Factory setting	d 1
Setting range	d 0	No function		
	d 1	Inverter running		
	d 2	Frequency arrival		
	d 3	Zero speed		
	d 4	Over-torque detection		
	d 5	During external alarm		
	d 6	Low voltage detection		
	d 7	External terminal running mode		
	d 8	Alarm output(for any alarm)		
	d 9	Frequency detection		
	d 10	During pattern operation		
	d 11	Pattern operation one cycle completion		
	d 12	Pattern operation completion		
	d 13	Pattern operation pause		
	d 14	Terminal count value arrival		
	d 15	Terminal designated count value arrival		
	d 16	Inverter ready to run		
	d 17	Fwd running		
	d 18	Rev running		
d 19	Fwd/ Rev running direction			

This function corresponds to external terminal MO1, DCM(open-collector output). Different system signals output can be obtained if set value of 3-09 as per above table. The function description is same as that of in 3-05

3-10	Reserved		
------	----------	--	--

3-11	Dead time setting of Fwd and Rev changeover		Factory setting	d 0.0
	Setting range	d 0.0 <-> d 600s	Unit	0.1s

This parameter is used to set FWD/REV switching interval.

3-12	Cooling fan control		Factory setting	d 0
Setting range	d 0	Fan continuous running		
	d 1	Run for 1 minute after pressing stop key		
	d 2	Operate/stop along with diver		

This parameter determines the action mode of cooling fan.

3-13	Bias [AVI] (Bias base point)		↗ Factory setting	d 0.0
	Setting range	d 0.0<-> d 10.0V	Unit	0.1V
3-14	Bias [AVI] (Bias value)		↗ Factory setting	d 0.0%
	Setting range	d 0.0%<-> d 100% of Maximum Frequency	Unit	0.1%
3-15	Analog input Adjustment for [AVI] (Gain base point)		↗ Factory setting	d 10.0
	Setting range	d 0.0<-> d 10.0V	Unit	0.1V
3-16	Analog input Adjustment for [AVI] (Gain)		↗ Factory setting	d 100%
	Setting range	d 0.0%<-> d 100% of Maximum Frequency	Unit	0.1%

These four parameters correspond to the condition when 2-00 or 2-01 is set as 1 (external terminal AVI input DC 0 to +10V).

3-17	Bias [ACI] (Bias base point)	↗	Factory setting	d 4.0
	Setting range	d 0.0<-> d 20.0mA	Unit	0.1mA
3-18	Bias [ACI] (Bias value)	↗	Factory setting	d 0.0%
	Setting range	d 0.0%<-> d 100% of Maximum Frequency	Unit	0.1%
3-19	Analog input Adjustment for [ACI] (Gain base point)	↗	Factory setting	d 20.0
	Setting range	d 0.0<-> d 20.0mA	Unit	0.1mA
3-20	Analog input Adjustment for [ACI] (Gain)	↗	Factory setting	d 100%
	Setting range	d 0.0%<-> d 100% of Maximum Frequency	Unit	0.1%

These four parameters correspond to the condition when 2-00 or 2-01 is set as d2 (external terminal ACI input DC 4 to 20mA).

The jumper cap has to switch to current ACI input (4 to 20mA).

Above eight parameters define the corresponding relationship between analog input voltage/current and frequency.

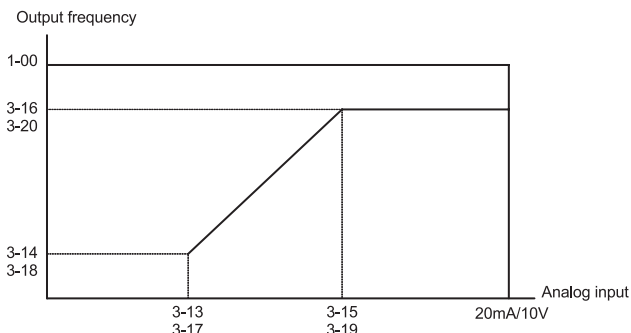

Example:

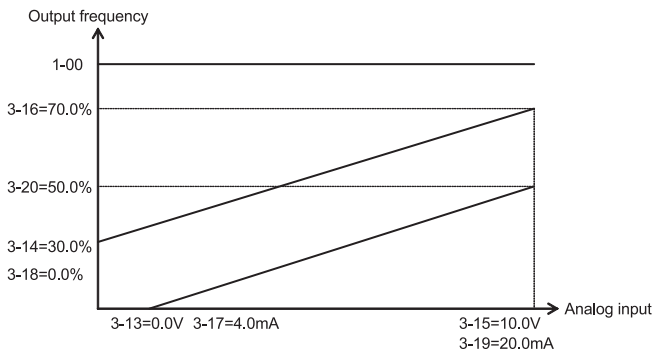

3-21	Reserved
-------------	----------

3-22	Reserved
-------------	----------

4. INPUT FUNCTION PARAMETERS

4-00	[VR] Input frequency bias setting	↗	Factory setting	d 0.0
	Setting range	d 0.0<->d 350Hz	Unit	0.1Hz

4-01	[VR] Input frequency bias adjustment direction	↗	Factory setting	d 0
	Setting range	d 0 Positive direction d 1 Negative direction		

4-02	[VR] Input frequency gain setting	↗	Factory setting	d 100
	Setting range	d 1<->d200%	Unit	1%

4-03	[VR] Negative bias operation setting		Factory setting	d 0
	Setting range	d 0 No negative bias d 1 Reversible negative bias d 2 Not reversible negative bias		

The parameters above is used for functions from 4-00 to 4-03, all of which set applied parameter by setting and adjusting analog signals on digital operation keypad, please refer to the following examples. In addition, the negative bias d2 in parameter 4-03 is not reversible refers to that the inverter remains operating in current direction instead of reversing direction when frequency reaches the reverse frequency by adjusting the potentiometer on digital operation keypad . But the rotating direction can be switched over by button or outside terminal, in order to adjust the motor rotating direction.

Example 1:

This is the most frequently used adjustment method in the industry. The user only need to set the parameter 2-00 or 2-01 to 3(controlled by VR on digital operation keypad), then the frequency can be set by using the potentiometer on digital operation keypad .

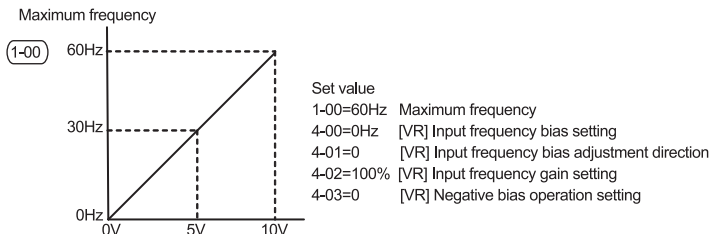

Example 2:

This example is used in the industry when operating inverter. They hope the regulation resistance to be set is 10Hz when it rotates to the leftmost point, that is, the min input of inverter must be 10Hz when starting, and the other frequency then be adjusted by the industry itself. The diagram shows that at this time the relationship between VR and the set frequency has changed from 0 to 10V corresponding to 0 to 60Hz into 0 to 8.33V corresponding to 10 to 60Hz. Therefore, the central point of the regulation resistance becomes 40Hz and becomes 60Hz in the posterior segment of the regulation resistance. In order to make the posterior segment of the regulation resistance can be operated, please refer to example 3.

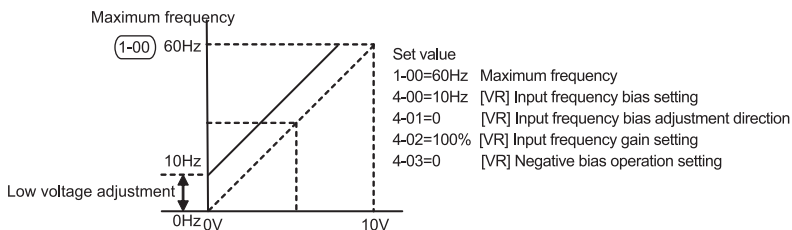

Example 3:

This example is also a frequently used example in the industry. The setting of regulation resistance can make the best use of all range, which can increase its flexibility.

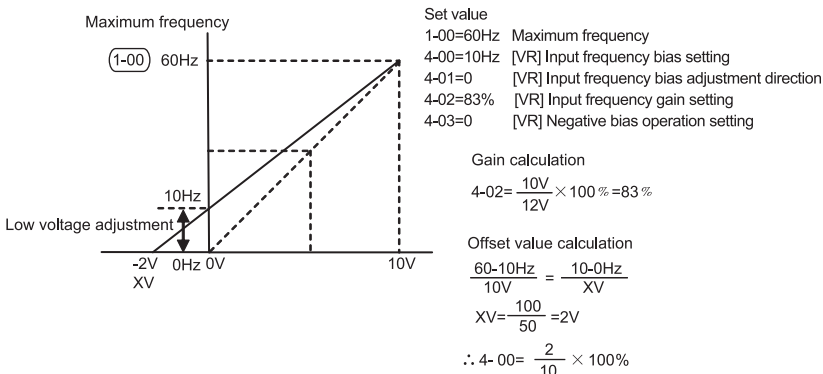

4-04	Terminal [MI1] Function	Factory setting	d 1
	Setting range	d 0<->d 31	

4-05	Terminal [MI2] Function	Factory setting	d 0
	Setting range	d 0,d 5<->d 31	

4-06	Terminal [MI3] Function	Factory setting	d 8
	Setting range	d 0,d 5<->d 31	

4-07	Terminal [MI4] Function	Factory setting	d 9
	Setting range	d 0,d 5<->d 31	

4-08	Terminal [MI5] Function	Factory setting	d 7
	Setting range	d 0,d 5<->d 31	

Function List

Set value	Function	Set value	Function
d 0	No function	d 16	External alarm, normally closed(NC) input
d 1	MI1: forward run/stop, MI2: reverse run/stop	d 17	UP COMMAND
d 2	MI1: run/stop, MI2: fwd/rev	d 18	DOWN COMMAND
d 3	3-wire operation control(1): MI1 run, MI2 fwd/rev run, MI3 STOP(Normally closed)	d 19	Pattern operation command
d 4	3-wire operation control(2): MI1 run (Triggering), MI2 run(Triggering), MI3 STOP(Normally closed)	d 20	Pattern operation pause command
d 5	External fault(EF), normally open interface input (N.O)	d 21	JOG frequency reference
d 6	External fault(EF) normally closed interface input (N.C)	d 22	Count reset
d 7	RESET alarm	d 23	Reserved
d 8	Select multi-frequency (0 to 1 steps)	d 24	JOG-FWD
d 9	Select multi-frequency (0 to 3 steps)	d 25	JOG-REV
d 10	Select multi-frequency (0 to 7 steps)	d 26	Reserved
d 11	Reserved	d 27	Wobble frequency function input
d 12	Select frequency command 2/1	d 28	Wobble frequency state reset
d 13	Accel /decel inhibition command	d 29	Inhibiting output (N.O)
d 14	Select 1 ST and 2 nd Accel/Decel time	d 30	Inhibiting output (N.C)
d 15	External alarm, normally open (NO) input	d 31	Counter trigger signal input

Explanation of functions:

No function (d0):

Description of action: No function terminal is set to isolate the external terminals, which shall be free from alarm action in unclear cause.

Operational terminals setting for external terminals (d1, d2, d3 and d4)

2-wire operation control 1 (d1):

Controlling parameter 4-04, terminal MI1 and MI2, in which MI1: forward run/stop, MI2: reverse run/stop. When 4-04 is set as d1, function set by MI2 is invalid.

2-wire operation control 2 (d2):

Controlling parameter 4-04, terminal MI1 and MI2, in which MI1: run/stop, MI2: forward /reverse run. When 4-04 is set as d2, function set by MI2 is invalid.

3-wire operation control 1 (d 3):

Controlling parameter 4-04, terminal MI1, MI2 and MI3, in which MI1 run, MI2 fwd/rev run, MI3 STOP(Normally closed). When 4-04 is set as d3, function set by MI2 and MI3 is invalid. The wiring diagram is as follows.

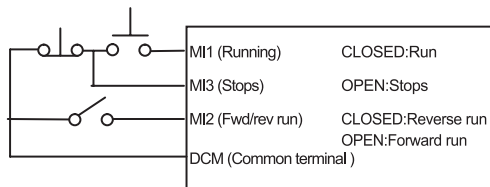

3-wire Control (1)

3-wire operation control 2 (d 4):

Controlling parameter 4-04, terminal MI1, MI2 and MI3, in which MI1 forward run (Triggering), MI2 reserve run(Triggering), MI3 STOP(Normally closed). When 4-04 is set as 4, function set by MI2 and MI3 is invalid. The wiring diagram is as follows

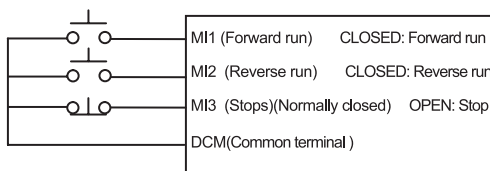

3-wire Control (2)

Note: The corresponding function of MI2 and MI3 will be restored when 4-04 is not set as from 1 to 4.

External fault (EF) input (d5, d6)

Description of action: once the inverter receives external fault (EF) signal, the output will be stopped immediately and EF will be displayed on digital operation keypad. At this moment, the motor rotates freely. The operation can be continued through pressing RESET after disappearing of external fault.

External RESET input (d7):

Description of action: Provided that alarms such as EF, OH, OC or OV occur to the inverter, Terminal RST shall be applied after cause eliminated to reset the inverter. The terminal is in a same function with RESET key on the digital operation keypad.

Multi-frequency input (d8, d9, d10):

Description of action: 8 step speeds in total shall be commanded by this 3 terminal switches. Relative parameters are (5-00 to 5-06) and main speed setting. Apart from relative parameters, multi-frequency operation shall also be supported by operation reference. Pattern-operation shall also be available by this function cooperating with program running. For setting of this function, see 5-18 to 5-25 for detailed descriptions.

Function d11 is reserved.

Frequency command 2/1 switch (d12)

Description of action: when it is used to set the switching action of terminals. The frequency source of inverter will be switched to 2-01 given (Frequency command 2) from 2-02 given (combination way of frequency sources) and return to 2-02 given when the switch is turned off.

Accel /decel inhibition command input (d13)

Description of action: In performing Accel/decel inhibition function, Accel/decel of inverter shall be stopped immediately. When this function is cancelled, Accel/decel of AC motor drive shall be continued from inhibition place. This reference shall only be available during acceleration or deceleration of the inverter.

Select 1st and 2nd Accel/Decel time (d14):

Description of action: Prior to closing of terminals switch, the accel/decel time of inverter shall be in accordance with setting of Parameters 1-09 and 1-10. During switch closing, accel/decel time shall be in accordance with setting of Parameters 1-11 and 1-12. If inverter is in constant speed, changing of switches shall not influence output frequency, which shall be effective when acceleration or deceleration of inverter is performing.

Reference input during external alarm (d15, d16):

Description of action: When switch of this terminal acts, output of inverter shall stop immediately and motor run freely. After switch reset, inverter shall firstly track upwards from frequency before interruption to holding rotating speed, and then accelerate to set frequency. Even if motor has stopped completely after b.b, speed tracking shall be performed once switch reset.

UP/DOWN frequency reference input (d17, d18):

Description of action: This parameter has to match with 2-00 or 2-02 (when set as 6 or 7) to modify the given frequency. When switch of this terminal in action, frequency of inverter shall happen the corresponding modification. The increase and decrease rate of frequency is determined by acceleration and deceleration time. It is valid only in operation state. The given frequency is cleared to 0 when stop.

Input of Pattern- operation command (d19):

cooperate with parameters of 5th group.

Input of Pattern -program operation pause reference (d20):

cooperate with parameters of 5th group.

Description of action: When switch for Pattern operation is in operation, output frequency of inverter shall run in accordance with setting of Parameter group 5-00 to 5-06. Pause terminal can interrupt running program during running, and after reset, operation program shall be performed continuously. For detailed description for action, see Parameter 5-15.

JOG frequency reference (d21):

Description of action: When external terminal is set with this function, JOG set frequency (1-15) shall be available by short circuiting of this terminal; original frequency reference shall be reset after the circuit open.

Count reset (d22):

Description of action: Current counting display shall be reset by action of this terminal, and "C 0" shall be restored. Counting upwards of the inverter from triggering signal shall not be available until this signal disappears. Function d23 is reserved.

JOG FWD (d24):

Jog forward run. For relative application, see description of Parameters (1-13, 1-14 and 1-15)

JOG REV (d25):

Jog reverse run. For relative application, see description of Parameters (1-13, 1-14 and 1-15)

Description of action: When jog function is performed while the inverter is in stop, the jog acceleration and deceleration time (1-13, 1-14) shall be subject to. Jog run reference shall only be used when the Inverter in stop and [STOP] key from the digital operation keypad shall be available

d26 is reserved.

Wobble frequency function input (d27):

Description of action: If wobble frequency starting is manual, wobble frequency status shall be available when terminals are closed; when terminals open, wobble frequency function shall be cancelled and the operation frequency keeps at wobble frequency preset frequency A-02.

Wobble frequency function reset (d28):

Description of action: For both auto and manual selection of wobble frequency function, when this terminal is closed, wobble frequency state information in memory shall be cancelled, and operation frequency shall be preset; after opening the terminal, wobble frequency shall restart, and if it was auto input mode, wobble frequency state shall only be available after wobble frequency delay time.

Inhibiting output (d29, d30):

This function provides the motor drive to receive emergency stop contactor from electrical system or other alarm signals without any alarm output or RESET. After stop, operation shall only be available after operation signal re-input, and inverter shall restart from 0Hz.

Counter trigger signal input (d31):

It shall not be used together with Parameter 0-04, 3-01 and 3-02 and if all set to 0, counting shall not vary.

Description of action: This function terminal TRG can use external triggering signals (e.g. signals near switch, photoelectric inductors) to make inverter count. And control application based on counting shall be completed by reference signal of multifunctional output terminals (counting agreement, random counting agreement). Examples are coiling machine and packing machine.

4-09	Speed tracking after external alarm reset		Factory setting	d 0
	Setting range	d 0	Tracking downwards from speed before external alarm	
		d 1	Tracking upwards from min speed	

This function can set the starting mode of inverter after external alarm is reset. The action sequence is same as sequence after the transient power failure. For detailed action description, see Parameters 8-04 to 8-07 and diagrams.

4-10 to 4-22	Reserved
---------------------	----------

5. MULTI-STEP SPEED AND PATTERN OPERATION PARAMETERS

5-00	Multi frequency 1	↗	Factory setting	d 0.0
5-01	Multi frequency 2	↗	Factory setting	d 0.0
5-02	Multi frequency 3	↗	Factory setting	d 0.0
5-03	Multi frequency 4	↗	Factory setting	d 0.0
5-04	Multi frequency 5	↗	Factory setting	d 0.0
5-05	Multi frequency 6	↗	Factory setting	d 0.0
5-06	Multi frequency 7	↗	Factory setting	d 0.0
	Setting range	d 0.0<->d 400Hz		Unit
				0.1Hz

Multi-frequency operation (8-step as maximum value) shall be available by means of multi-function input terminals (see 4-04 to 4-08 for reference), the step frequency shall be set respectively within a range of 5-00 to 5-06. Pattern operation shall be available in cooperation to parameters (5-18 to 5-25).

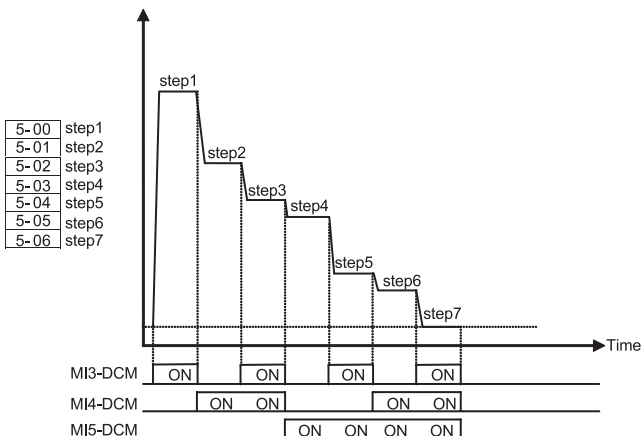

5-07 to 5-14 Reserved

5-15	Pattern Operation (Mode)	Factory setting	d 0
	Setting range	d 0	Pattern operation inactive
		d 1	Active(Stop after operating for 1 cycle)
		d 2	Active (Pattern operation performs in cycles until STOP command input)
		d 3	Active(Stop after operating for 1 cycle) (with STOP intervals).
		d 4	Active (Pattern operation performs in cycles until STOP command input) (with STOP intervals).

This parameter shall be applicable for operation process control of general micro machine, food treatment machine and washing machine, and some control wiring such as traditional relay, switch and timing machine shall be replaced; when this function is used, many parameters shall be set, and attention shall be paid to each detail. Read descriptions below carefully.

5-16	(Rotating Direction) (0 to 7th step speed)		Factory setting	d 0
	Setting range	d 0<-> d 255 (0: Forward run; 1: Reverse run)	Unit	1

This parameter determines rotating direction of programming operation 5-00 to 5-06 as well as all step running of the master speed.

Setting method: Operation direction setting is in binary 8 bit, and only input this parameter after it is transferred into decimal value.

5-17	Reserved			
-------------	----------	--	--	--

5-18	Pattern Operation (Step 0 Time)		Factory setting	d 0
5-19	Pattern Operation (Step 1 Time)		Factory setting	d 0
5-20	Pattern Operation (Step 2 Time)		Factory setting	d 0
5-21	Pattern Operation (Step 3 Time)		Factory setting	d 0
5-22	Pattern Operation (Step 4 Time)		Factory setting	d 0
5-23	Pattern Operation (Step 5 Time)		Factory setting	d 0
5-24	Pattern Operation (Step 6 Time)		Factory setting	d 0
5-25	Pattern Operation (Step 7 Time)		Factory setting	d 0
	Setting range	d 0<->d 65500s	Unit	1s

Time setting for 8 parameters above refers to time which fits each step of pattern operation. Max of the parameter shall be 65500 sec, and display shall be d 65.5.

Special description: When this parameter is set to d0 (0 sec), it means that operation for this step is omitted and operation of next step shall be performed automatically. This means that although 8 steps are provided by the inverter, users can minify it into 2 steps according to specific requirements, this function can be realized by set time of the step which shall be omitted to d0 (0 sec).

5-26 to 5-33	Reserved			
---------------------	----------	--	--	--

6. PROTECTION PARAMETERS

6-00	Over voltage stall prevention function		Factory setting	d 370,d 740
	Setting range	d 0	Inactive	
		d 1	200V series: 340V-400V 400V series: 680V-800V	

When deceleration is performed, back-up energy may be generated in motor drive due to inertia of motor load, and DC side voltage may rise to max value. Thus, when over voltage stall prevention is started, over voltage at DC side shall be detected, and deceleration shall be interrupted (output frequency shall be kept), which will not be performed again by inverter until voltage is below setting value.

Techniques Forum

This function is set for uncertain load inertia circumstances. Deceleration over voltage shall not occur in normal load stop, and deceleration time shall also be applicable. However, tripping shall not occur due to over voltage in occasional load back up inertia increase stop; in these occasions, deceleration time shall be increased automatically by the inverter to stop. This function is inapplicable provided that deceleration time disturbs application. This problem shall be solved by increasing deceleration time or install braking module to absorb excessive back up voltage.

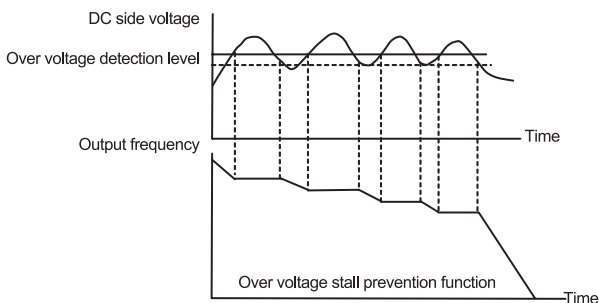

6-01	Over current stall prevention level setting		Factory setting	d 170
	Setting range	d 0	Inactive	
		d 1	d 20<->d 200%	Unit 1%

During operation of AC motor drive, provided that output current exceeds set value of 6-01 (Over current stall prevention current level during running), output frequency shall be decreased by AC motor drive to prevent motor stalling. AC motor drive shall perform acceleration again to set frequency when output current is below setting of 6-01. Set unit shall be percentage of rated output current (100%) of the AC motor drive.

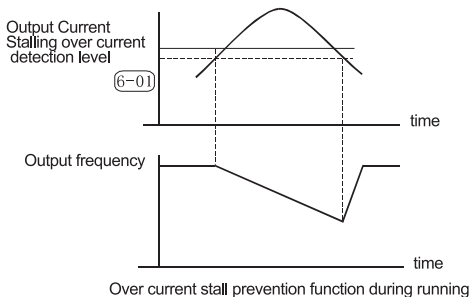

6-02	Over-torque detection (mode selection)	Factory setting	d 0
	Setting range	d 0	No detection
		d 1	Over torque detection (OL2) during constant speed running, continue to run after detection.
		d 2	Over torque detection (OL2) during constant speed running, stop running after detection.
		d 3	Over torque detection (OL2) during acceleration and constant speed running, continue to run after detection.
		d 4	Over torque detection (OL2) during acceleration and constant speed running, stop running after detection.

When this parameter sets the action of inverter when OL2 actuates, no action when set as 0. When set as other values, the operation keypad will display OL2 alarm when OL2 actuates. d1 or d3 setting shows that the inverter continues to operate after alarm error occurs. The rest of OL2 alarm needs to its automatic reset after the alarm disappears or stop the inverter and reset alarm simultaneously. d2 or d4 setting indicates that the inverter stops operating after alarm happens. Press RESET key to reset OL2 alarm after 5 seconds. Determine whether setting this function at constant speed or accelerated speed is more effective according to the actual usage.

6-03	Over-torque detection (Detection level)	Factory setting	d 150
	Setting range	d 30<->d 200%	Unit
			1%

Set Over torque detection level, unit shall be percentage of rated current (100%) of inverter.

6-04	Over-torque detection time	Factory setting	d 0.1
	Setting range	d 0.1<->d 10.0s	Unit
			0.1s

Over-torque detection method: This contactor shall be closed, if output current exceeds over torque detection level (6-03 set value; factory setting: 150%) and 6-04 setting for over torque detection time (Factory setting: 0.1 sec) and if "multifunctional output terminal" is set to over torque detection reference. See descriptions in 3-05.

6-05	Electronic thermal overload protection for Motor (Select motor characteristics)	Factory setting	d 0
	Setting range	d 0	Inactive
		d 1	Active(For a general-purpose motor with shaft-driven cooling fan)
		d 2	Active(For a motor with separately powered cooling fan)

To prevent over-heating of a motor, users shall set electronic relay to control the output frequency of inverter within allowable range.

6-06	(Thermal time constant)	Factory setting	d 60
	Setting range	d 30<->d 600s	Unit
			1s

This parameter sets time of I²t protection relay characteristics of electronic relay, with three categories available: Short-time rated, standard rated and long-time rated.

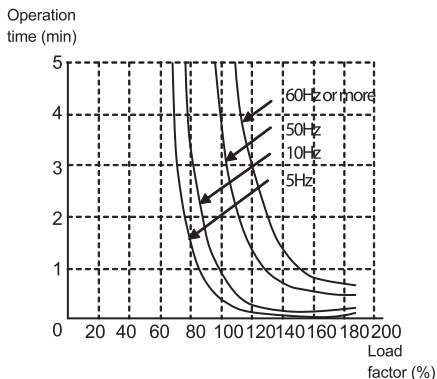

6-07	Alarm history (Latest)	Factory setting	d 0
6-08	Alarm history (1 st last)	Factory setting	d 0
6-09	Alarm history (2 nd last)	Factory setting	d 0
6-10	Alarm history (3 rd last)	Factory setting	d 0
6-11	Alarm history (4 th last)	Factory setting	d 0
6-12	Alarm history (5 th last)	Factory setting	d 0
	Setting range	Non	

Parameters 6-07 to 6-12 is available to record alarm signals of recent six times. Inverter shall be reset to prepared station provided that alarm has been eliminated. Records of 6 times shall not be reset to factory setting due to parameter reset.

Value meaning

d 0	No alarm records	d 16	CF2 (read error of internal storage IC data)
d 1	OC (over current)	d 17	External alarm signal input
d 2	OV(over voltage)	d 18	OL2(motor overload)
d 3	OH (over heating)	d 19 to d 21	Reserved
d 4	OL(inverter overload)	d 22	CF3.1 (Internal temperature is over high or circuit fault at power-on test)
d 5	OL1(motor overload)	d 23	CF3.2(over voltage of internal DC voltage side at power-on test)
d 6	EF (external fault)	d 24	CF3.3(under voltage of internal DC voltage side at power-on test)
d 7 to d15	Reserved	d 29	HPF.1(over voltage protection circuit fault)
		d 31	HPF.3(over current protection circuit fault)
		d 37	Errb (wobble frequency setting error)

7. SPECIAL PARAMETERS

7-00	Motor (Rated current)		Factory setting	d 85
	Setting range	d 30<->d 120%	Unit	1%

This parameter must be set according to specifications on nameplate of the motor. Factory setting shall be set according to rated current of inverter. By this parameter, output current of inverter shall be controlled to prevent motor overheat.

7-01	Motor (No load current)		Factory setting	d 30
	Setting range	d 0<->d 90%	Unit	1%

This parameter is to set no load current of motor; it shall influence torque compensation, and rated current of the inverter shall be 100%; this parameter setting must be lower than setting of Parameter 7-00.

7-02	Auto torque compensation setting		Factory setting	d 0.0
	Setting range	d 0.0<->d 30.0	Unit	0.1

This parameter can set AC motor drive to automatically output additional voltage when rotating in order to get a higher torque.

7-03	Auto slip compensation setting		Factory setting	d 0.0
	Setting range	d 0.0<->d 10.0	Unit	0.1

Since load and slip shall increase when inverter drives asynchronous motor, this parameter(set value: 0.0-10.0) can set compensation frequency to decrease slip and provide the motor running speed under rated current approach synchronous rotating speed. When output current of AC motor drive exceeds motor no load current (7-01 set value), the inverter shall compensate frequency in accordance with this parameter.

7-04 to 7-10	Reserved
---------------------	----------

7-11	Motor (Rated speed)		Factory setting	d 1450
	Setting range	d 500<->d 3000min ⁻¹	Unit	1min ⁻¹

This parameter must be set up in accordance with the specifications in the nameplate of the motor.

7-12	Motor (Pole number)		Factory setting	d 4
	Setting range	d 0<->d30pole	Unit	2pole

This parameter can set number of pole. (can't be odd).

7-13	Motor (Rated frequency)		Factory setting	d 50.0
	Setting range	d 5.0<->d 400	Unit	0.1Hz

This parameter must be set according to the nameplate specification of motor.

7-14 to 7-74	Reserved
---------------------	----------

8. HIGH FUNCTION PARAMETERS

8-00	DC braking (Braking level)	Factory setting	d 0.0
	Setting range	d 0.0<->d 100%	Unit
			0.1%

Description of parameter: This parameter sets DC braking level of motor at starting or stopping; braking capability shall increase as DC braking percentage increases. However, pay attention that setting shall be increased gradually enough torque appear. And great care shall be given that this braking percentage must be free from overlarge.

8-01	DC braking (Braking time at starting)	Factory setting	d 0.0
	Setting range	d 0.0<->d 60.0s	Unit
			0.1s

This parameter is to set time lasting of DC braking voltage input to motor during start of AC motor drive.

8-02	DC braking (Braking time setting at stopping)	Factory setting	d 0.0
	Setting range	d 0.0<->d 60.0s	Unit
			0.1s

This parameter is to set time lasting of DC braking voltage input to motor during braking. If DC braking is necessary at stop, this function shall be available if Parameter 2-04 is set to deceleration and stop (d0).

8-03	DC braking (Braking starting frequency)	Factory setting	d 1.0
	Setting range	d 0.1<->d 60.0Hz	Unit
			0.1Hz

This parameter is to set DC braking starting frequency from deceleration to stop of AC motor drive. When set value is below Starting frequency (1-05), starting frequency of DC braking shall begin from Starting frequency.

Notice: If the parameter is set to be too high, over current (OC) alarm may occur.

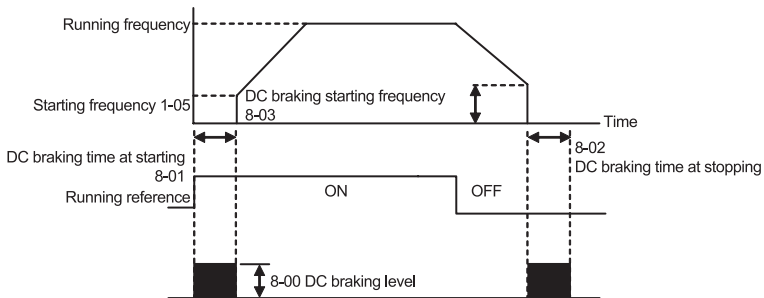

Techniques Forum:

DC braking before running is generally applied in circumstances which load can move when machine such as fan or pumps stop. For these loads, prior to AC inverter start, motor is generally in free rotating, while direction is uncertain. Prior to start, it is advisable to perform DC braking before starting motor. DC braking at stopping is generally used in circumstances when motor is suggested to be braked quickly, or for control of location, such as traveling crane and cutting machine.

8-04	Restart after momentary power failure (Mode selection)	Factory setting	d 0
	Setting range	d 0	Inactive(Trip immediately)
		d 1	Active(Restart at the frequency at which the power failure occurred, for general loads)
		d 2	Active(Restart at the starting frequency, for light inertia loads)
8-05	Max allowable time for power failure	Factory setting	d 2.0
	Setting range	d 0.3<->d5.0 s	Unit
			0.1s

This parameter shall set Max allowable time for power loss in case of momentary power loss and if function of Restart after momentary power failure is started. If power supply breaking time exceeds Max allowable time, output of AC inverter shall stop after power resupplied.

8-06	Restart after momentary power failure (Restart time)	Factory setting	d 0.5
	Setting range	d 0.3<->d 5.0s	Unit
			0.1s

If power supply interruption is detected, AC motor drive shall stop output and shall not be re-started until after set time by this parameter. It's preferred to provide output side residual voltage to be approximately 0V prior to inverter starting.

When setting external B.B and restart after alarm , this parameter shall be time for speed tracking.

8-07	(Max current setting for speed tracking)	Factory setting	d 150
	Setting range	d 30<->d 200%	Unit
			1%

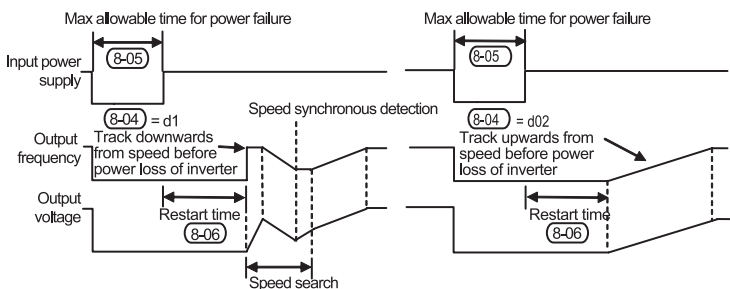

8-08	Jump Frequency1 (Upper)	Factory setting	d 0.0
8-09	Jump Frequency1 (Lower)	Factory setting	d 0.0
8-10	Jump Frequency2 (Upper)	Factory setting	d 0.0
8-11	Jump Frequency2 (Lower)	Factory setting	d 0.0
8-12	Jump Frequency3 (Upper)	Factory setting	d 0.0
8-13	Jump Frequency3 (Lower)	Factory setting	d 0.0
	Setting range	d 0.0<->d 400Hz	Unit
			0.1Hz

Parameters above define inhibited frequency setting, and this range shall be avoided from frequency setting for inverter, reason is that frequency output shall not be stable at these ranges but shall stay beyond these ranges of frequency. However, since frequency output shall be continuous, when frequency is not set within these ranges, frequency output shall be continuous and jumping shall not occur at locations of inhibition frequency.

8-14	Auto-reset (Times)	Factory setting	d 0
	Setting range	d 0<->d 10	

Times of auto restarting of inverter shall be set to 10 times after alarm (for alarm allowable situations: OC (over current) and OV (over voltage)). If it is set to 0, auto-reset/restarting function shall not be performed. In restarting after alarm, AC motor drive shall be started in speed tracking mode up to down.

8-15	AVR function selection	Factory setting	d 1
	Setting range	d 0	AVR function available
		d 1	AVR function unavailable
		d 2	AVR function cancelled during deceleration

Inverter rating generally consists of AC 220V/200V and 60Hz/50Hz; input voltage of inverter ranges from AC 180V to 264V, 50Hz/60Hz; Thus, for inverter without function of auto-voltage stabilizing, if input power supply of motor is AC 250V, a same voltage shall be output from motor, and motor shall then run in a power supply which is 12% to 20% more than rated voltage. This will cause an increased temperature rise to motor. This shall also be unfavorable to insulation and torque output, thus, duration of motor shall be decreased sharply as a result.

Auto-voltage stabilizing function of inverter shall stabilize automatically output power supply to rated voltage of motor when input power supply exceeds rated voltage of the motor. For example, if V/f curve is set to AC 200V/50Hz and input power supply is in a range of AC200 to 264V, voltage output to motor shall be stabilizing automatically to AC 220V/50Hz, not exceeding the set voltage. If input power supply varies from AC 180 to 200V, voltage output to motor shall be proportional to input power supply.

It has been discovered that in deceleration to stop, time of deceleration shall be decreased when AVR function is closed. In addition with fine function of auto acceleration and deceleration, the accel/decel of motor shall be much more speeded.

8-16 to 8-19	Reserved
---------------------	----------

8-20	Auto-reset (Counter clear time)	Factory setting	d 10
	Setting range	d 1<->d100 min	Unit 1 min

Auto-reset (Counter clear time): every retry (including the waiting period before retry) will make the time of alarm restart minus 1. The inverter will not restart automatically when the alarm restart time has been decreased to 0. If OU and OC alarm don't happen in the time set by 8-20, the time of alarm restart will set to the time set by 8-14 automatically.

8-21	Reserved
-------------	----------

8-22	Auto-reset (Reset interval)	Factory setting	d 2.0
	Setting range	d 0.1<->d 20.0s	Unit 0.1s

It is the waiting time for alarm restart, which means the restart command will be performed after the time set by this parameter when alarm happens.

9. COMMUNICATIONS PARAMETERS

9-00	RS-485 Communications (Station address)	↗	Factory setting	d 1
	Setting range	d 1<->d 247		

If AC motor drive is set to RS-485 series communications interface control, each inverter shall set its individual address in this parameter. And each address in a same connection net shall be ONLY, shall not be repeated.

9-01	RS-485 Communications (Baud rate)	↗	Factory setting	d 1
	Setting range	d 0	Baud rate 4800 (data transmitting speed, bit/sec)	
		d 1	Baud rate 9600 (data transmitting speed, bit/sec)	
		d 2	Baud rate 14400 (data transmitting speed, bit/sec)	
		d 3	Baud rate 19200 (data transmitting speed, bit/sec)	
		d 4	Baud rate 38400 (data transmitting speed, bit/sec)	

Parameter in inverter shall be set and modified by inner communications interface (RS-485 series communications interface), and operation status of the inverter shall also be monitored by this parameter. This parameter is to set communications transmission speed.

9-02	RS-485 Communications (Communications error processing)	↗	Factory setting	d 0
	Setting range	d 0	Warning and running continuously	
		d 1	Warning and deceleration to stop	
		d 2	Warning and coast to a stop	
		d 3	No warning and running continuously	

This parameter is used to set the inverter state when communications error occurs.

9-03	RS-485 Communications (No-response error detection time)	↗	Factory setting	d 0
	Setting range	d 0	Unit	1s
		d 1		

9-04	RS-485 Communications (Communications format)	↗	Factory setting	d 0
	Setting range	d 0	Modbus ASCII Mode, Data format <8,N,1>	
		d 1	Modbus ASCII Mode, Data format <8,N,2>	
		d 2	Modbus ASCII Mode, Data format <8,E,1>	
		d 3	Modbus ASCII Mode, Data format <8,E,2>	
		d 4	Modbus ASCII Mode, Data format <8,O,1>	
		d 5	Modbus ASCII Mode, Data format <8,O,2>	
		d 6	Modbus RTU Mode, Data format <8,N,2>	
		d 7	Modbus RTU Mode, Data format <8,E,1>	
		d 8	Modbus RTU Mode, Data format <8,O,1>	
		d 9 to d 11	Reserved	

9-05	Reserved
9-06	Reserved

9-07	RS-485 Communications (Response interval)		Factory setting	d 1
	Setting range	d 0 to d 200 (one unit=2ms)		

A period of time is needed to switch the host computer from sending state to receiving state. This parameter can set the delay time to ensure the normal receiving of host computer.

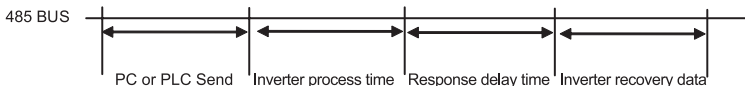

Computer control

For RS-485 series communications interface, each inverter shall be prepared with individual communications address in Parameter 9-00, thus computer shall control it based on the individual communications addresses.

Inverter is set to Modbus networks communications, and the following two modes are available: ASC II Mode(American Standard Code for Information Interchange) or RTU Mode (Remote terminal Unit). Users can set specific mode and communications agreements in Parameter 9-04.

Code Meaning of Modes:

ASC II Mode:

Each 8-bit data shall be consisted of two ASC II characters. For example: a 1-byte data 64H (hexadecimal) shall be indicated as "64" by ASC II code, consisting of "6" (36H) and "4" (34H).

Character symbol	'0'	'1'	'2'	'3'	'4'	'5'	'6'	'7'
ASCII code	30H	31H	32H	33H	34H	35H	36H	37H

Character symbol	'8'	'9'	'A'	'B'	'C'	'D'	'E'	'F'
ASCII code	38H	39H	41H	42H	43H	44H	45H	46H

RTU Mode:

Each 8-bit data consists of two 4-bit hexadecimal characters. For example: 64H.

Structure of characters:

11-bit character frame (used for 8-bit character) (explained in following examples)

(8,N, 2;parameter9-04=1 or 6)

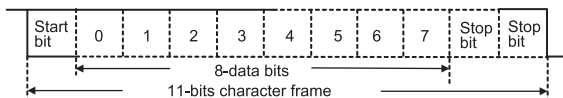

(8,O, 1:parameter9-04=4 or 8)

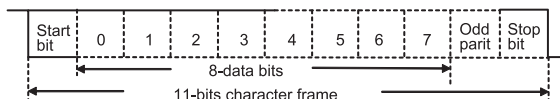

Communications data structure

Communications data frame form:

ASC II Mode:

STX	Starting characters(3AH)
ADR1	Communications address:
ADR0	8-bit address consists of 2 ASC II codes.
CMD1	Command code
CMD2	8-bit address consists of 2 ASC II codes.
DATA(n-1)	Data:
.....	N×8-bit data consists of 2n ASC II codes.
DATA 0	N≤25, 50 ASCII codes at most.
LRC CHK 1	Longitudinal Redundancy Check
LRC CHK 0	8-bit LRC consists of 2 ASC II codes.
END 1	END character:
END 0	END1=CR(0DH); END2=LF(0AH)

RTU Mode:

START	Inaction period of exceeding 10ms.
ADR	Communications address: 8-bit address
CMD	Command code: 8-bit command
DATA(n-1)	Data:
.....	N×8-bit data, N≤25
DATA 0	
CRC CHK Low	Cyclical Redundancy Check
CRC CHK High	16-bit CRC consists of two 8-bit characters
END	Inaction period of exceeding 10ms.

ADR (Communications address)

Allowable communications address shall range from 0 to 247. Communications address 0 indicates that communications shall be sent to all inverters. And in this case, inverter shall not response any signal to master device.

For example: Communications to inverter of which the communications address is 16 (decimal)

ASC II Mode:(ADR 1,ADR 0)='1','0'=>'1'=31H,'0'=30H

RTU Mode:(ADR)=10H

CMD (Command reference) and DATA (data character)

Format of data characters depends on command code. Available command code is explained below:

Command code: 03H, available to read N characters, Max (N) =12. For example: From address 01H to starting address 2102H of inverter to read 2 characters continuously.

ASCII Mode:

Command

STX	' : '
ADR1 ADR0	'0'
	'1'
CMD 1 CMD 0	'0'
	'3'
Starting data address	'2'
	'1'
	'0'
	'2'
Number of data (Counting in "word")	'0'
	'0'
	'2'
LRC CHIK 1 LRC CHIK 0	'D'
	'7'
END 1 END 0	CR
	LF

Response

STX	' : '
ADR 1 ADR 0	'0'
	'1'
CMD 1 CMD 0	'0'
	'3'
Number of data (Counting in "byte") Starting data address 2102H	'0'
	'4'
	'1'
	'7'
	'7'
Data address 2103H	'0'
	'0'
	'0'
LRC CHIK 1 LRC CHIK 0	'7'
	'1'
END 1 END 0	CR
	LF

RTU Mode:

Command

ADR	01H
CMD	03H
Starting data address	21H
	02H
Number of data (Counting in "word")	00H
	02H
CRC CHK Low	6FH
CRC CHK High	F7H

Response

ADR	01H
CMD	03H
Number of data (Counting in "byte")	04H
Starting data address 2102H	17H
	70H
Data address 2103H	00H
	00H
CRC CHK Low	FEH
CRC CHK High	5CH

Command code: 06H, write for one character (word), for example: write 6000(1770H) to Address 0100H of inverter in 0.1 H for address.

ASCII Mode:

Command

STX	' : '
ADR 1	' 0 '
ADR 0	' 1 '
CMD 1	' 0 '
CMD 0	' 6 '
Data address	' 0 '
	' 1 '
	' 0 '
	' 0 '
Data	' 1 '
	' 7 '
	' 7 '
	' 0 '
LRC CHK 1	' 7 '
LRC CHK 0	' 1 '
END 1	CR
END 0	LF

Response

STX	' : '
ADR 1	' 0 '
ADR 0	' 1 '
CMD 1	' 0 '
CMD 0	' 6 '
Data address	' 0 '
	' 1 '
	' 0 '
	' 0 '
Data	' 1 '
	' 7 '
	' 7 '
	' 0 '
LRC CHK 1	' 7 '
LRC CHK 0	' 1 '
END 1	CR
END 0	LF

RTU Mode:

Command

ADR	01H
CMD	06H
Data address	01H
	00H
Data	17H
	70H
CRC CHK Low	86H
CRC CHK High	22H

Response

ADR	01H
CMD	06H
Data address	01H
	00H
Data	17H
	70H
CRC CHK Low	86H
CRC CHK High	22H

CHK (check sum)

ASCII Mode:

LRC check sum (Longitudinal Redundancy check) is adopted by ASCII Mode. It is calculated as follows: get sum of data from ADR1 to the last one, unit of SUM shall be 256 in unit, and remove the extra bite(For example, for 128H of hexadecimal results, only 28H shall be accepted.), then perform quadratic counter bonification. For example, obtain one character from 0401H address of inverter to 01H address.

STX	' :
ADR 1	' 0'
ADR 0	' 1'
CMD 1	' 0'
CMD 0	' 3'
Initial data address	' 0'
	' 4'
	' 0'
	' 1'
Data	' 0'
	' 0'
	' 0'
	' 1'
LRC CHK 1	' F'
LRC CHK 0	' 6'
END 1	CR
END 0	LF

1H+03H+04H+01H+00H+01H=0AH, Quadratic counter bonification of 0AH shall be F6H)

RTU Mode:

CRC (Cyclical Redundancy Check) is adopted by RTU Mode, and CRC shall be calculated in following procedures:

Procedure 1:

Fit an FFFFH 16-bit Cache memory (Named as CRC Cache memory)

Procedure 2:

Perform "Exclusive OR" calculation on the first byte of Command and sequential byte of 16-bit Cache memory. And results shall be memorized in CRC Cache memory.

Procedure 3:

Move 1 bit rightwards for content of CRC cache memory, and the first left bit shall be completed with 0. Check for value of the lowest bit of CRC cache memory.

Procedure 4:

Repeat Procedure 3 if the lowest bit is 0; otherwise, perform "Exclusive OR" calculation on CRC cache memory and A001H.

Procedure 5:

Procedure 3 and Procedure 4 shall be repeated until content of CRC cache memory has been moved rightwards for 8 bits. At this time, this byte has completed treatment.

Procedure 6:

Procedure 2 to 5 shall be repeated to next byte of the command, until treatment to all bytes have been completed, and final data of CRC shall be value of CRC. Sequence of low byte and high byte shall be switched, which means that low byte shall be sent in priority.

For example, read 2 characters from the address which is at 2102H address of O1H inverter, the last content calculation of CRC Cache memory from ADR to the last character of number of data calculate is F76FH, then command signal is shown as follows, among which 6FH is sending before F7H:

Commands

ADR	01H
CMD	03H
Initial data address	21H
	02H
Data (Calculated by word)	00H
	02H
CRC CHK Low	6FH
CRC CHK High	F7H

Example:

CRC value below is generated from C++. And this function shall be assisted with two parameters:

```

    Unsigned char* data  ←//Data reference index
    Unsigned char length←//Length of data reference index
    Unsigned integer unsigned integer CRC for unsigned integer of this function
    unsigned int crc_chk(unsigned char* data,unsigned char length){
int j;
    unsigned int reg_crc= 0xffff;
    while(length--) {
        reg_crc =*data++;
        for(j=0;j < 8;j++) {
            if(reg_crc& 0x01) { /*LSB(b0)=1*/
                reg_crc=(reg_crc > > 1) 0×A001;
            } else {
                reg_crc=reg_crc > > 1;
            }
        }
    }
    return reg_crc    //Final value fit with CRC Cache memory
}

```

Definition of address in communications agreement:

Available addresses are listed below:

Function	Address	Content	
AC motor inverter parameters	ggnnH	gg: indicates parameter group, nn: indicates parameter, For example: 0401H, indicates parameter (4-01), Functions of parameters shall see descriptions before for reference, when catching parameter by from command code 03H, only one parameter shall be got for each time.	
Command (written only)	2000H	Bit 0,1	00: Blank 01: Stop reference 10: Run reference 11: JOG+RUN reference
		Bit 4,5	00: Blank 01: Fwd reference 10: REV reference 11: Changing direction
		Bit 2,3 Bit 6 to 15	Not used
	2001H	Frequency reference	
	2002H	Bit 0	1: E.F. ON (External fault)
		Bit 1	1: Reset reference
	2003H	Reserved	Bit 2
Monitor status (Reference read)	2100H	Error code	
		00: No alarm records	
		01: oc (Over current)	
		02: ov (Over voltage)	
		03: oh (Over heating)	
		04: oL (Drive over load)	
		05: oL1(Motor over load)	
		06: EF(External fault)	
		07: CPU writing alarm (cf1)	
		08: Reserved	
		09: HPF (Hardware circuit fault)	
		10: Reserved	
		11: Reserved	
		12: Reserved	
		13: Reserved	
		14: LV (Low voltage)	
		15: Reserved	
16: cF2(CPU read fault)			
17: b.b			
18: oL2 (Over torque)			
19: Reserved			
20: Reserved			

Function	Address	Content		
Monitor status (Reference read)	2101H	Bit 0,1	00: Stop LED off, Run LED on. 01: Stop LED blinks, Run LED ON. 10: Stop LED on, Run LED blinks. 11: Stop LED on, Run LED off.	
		Bit 2	1:JOG acts	
		Bit 3, 4	00: REV LED off, FWD LED on. 01: REV LED blinks, FWD LED on. 10: REV LED off, FWD LED blinks. 11: REV LED on, FWD LED off.	
		Bit 5 to 7	Reserved	
		Bit 8	1: Master frequency input from communications interface	
		Bit 9	1: Master frequency input from analog signal	
		Bit 10	1: Running reference input from communications interface	
		Bit 11	1: Parameter locking	
		Bit 12	0: Machine stop 1: During running	
		Bit 13	1: JOG reference appears	
		Bit 14,15	Reserved	
		2102H	Given combinations frequency(F)	
		2103H	Output frequency (H)	
		2104H	Output current (A)	
	2105H	DC-Bus voltage(U)		
	2106H	Output voltage(E)		
	2107H	Current step speed for multi-step speed reference (step)		
	2108H	PLC rotating speed (step)		
	2109H	PLC rotating time(sec)		
	210AH	External trigger count(count)		
	2113H	Main frequency command (o)		
2114H	Auxiliary frequency command (b)			

Abnormal response:

Except for broadcast data, the inverter shall feedback a normal signal after receiving command from master device. Circumstances of abnormal feedback to master device are described below:

Inverter receives no signal due to communications error. Thus inverter has no response. This shall be treated as timeout status finally by master device.

In case of inverter receives signals correctly, but treating this signal is unavailable, an abnormal signal shall be sent back to master device, and digital operator shall display fault signal "CE xx". "xx" is an abnormal signal in decimal. In abnormal response, highest byte of original command code shall be set to 1, and abnormal code which explains the abnormal information shall be feedback.

Example below shows abnormal response of communications command 06H and abnormal code 02H, in which the highest byte of 06H is set to 1 thus, it becomes 86H.

ASCII Mode:

STX	‘:’
ADR 1	‘0’
ADR 0	‘1’
CMD 1	‘8’
CMD 0	‘6’
Abnormal code	‘0’
	‘2’
LRC CHK 1	‘7’
LRC CHK 0	‘7’
END 1	CR
END 0	LF

RTU Mode:

ADR	01H
CMD	86H
Abnormal code	02H
LRC CHK Low	C3H
LRC CHK High	A1H

Meaning of abnormal code is shown below:

Abnormal code	Meaning	
1	Unavailable command code	In command signals, command code received is unavailable to drive the Ac motor inverter.
2	Unavailable data address	In command signals, data address received is unavailable to drive the Ac motor inverter.
3	Unavailable data value	In command signals, data value is not within allowable range.
4	Command unavailable	Required action cannot be performed by AC motor inverter.

■ No signals are received by inverter, but a communications error was detected, thus no signals feedback, but a fault signal "CE xx" shall be displayed on control keypad. It shall be finally treated with timeout status by the master device. 'xx' is a decimal fault code, which is explained in detail below:

Error code	Meaning
5	Reserved
6	Intervals between commands too short. At least 10ms interval must be provided between two available commands. If no command feedback, this interval shall also be kept.
7	Reserved
8	Reserved
9	Check sum error: to check that check sum is correct.
10	Time-out(Only for ASC II Mode) Apart from no check on time out limit, time intervals between characters shall not exceed 500ms.
11	Format error Check that communications Baud rate complies with data format.
12	Command information too short
13	Command information length is not within specified range.
14	Apart from characters of START and END, command information also includes ASC II data which is non "0" to "9" or "A" to "F".(Only for Modbus ASC II mode)

A-01	Wobble Frequency input mode	Factory setting	d 0
	Setting range	d 0	Set according to wobble frequency action delay
		d 1	Controlled by external terminals.

This parameter is to set input mode of wobble frequency:

When it is set to d0, it shall be input automatically. In this case, it shall firstly run for a period (A-03) in wobble frequency preset frequency (A-02) after starting, and then wobble frequency shall be realized automatically.

When it is set to d1, it shall be controlled manually by external terminals. Which means that wobble frequency shall be realized when multifunction terminal (Function 27 is for wobble frequency input) available; while wobble frequency shall not exist when terminal unavailable, with running frequency kept at wobble frequency preset frequency A-02.

A-02	Pre-set frequency of wobble frequency	Factory setting	d 0.0
	Setting range	d 0.0<->d 400Hz	Unit 0.1Hz

Operation frequency of the inverter prior to wobble frequency running status shall be determined by this parameter.

A-03	Action delay setting of preset wobble frequency	Factory setting	d 0.0
	Setting range	d 0.0<->d 600s	Unit 0.1s

When auto-restarting is in option, A-03 is to set the delay time running in preset frequency of wobble frequency; and it shall be unavailable when inverter is set to manually control mode.

A-04	Central frequency of wobble frequency	Factory setting	d 0
	Setting range	d 0	According to operation frequency source
		d 1	According to fixed frequency setting(A-05)
A-05	Fixed central frequency setting of wobble frequency	Factory setting	d 20.0
	Setting range	d 0.01<->d 100% (Corresponding Maximum Frequency Operation)	Unit 0.1%
A-06	Reference source setting for wobble aptitude	Factory setting	d 0
	Setting range	d 0	Centering frequency base
		d 1	Max frequency(1-00) base

Wobble frequency running is limited by min and max setting. Fault shall occur if it not set properly.

A-07	Wobble aptitude width setting	Factory setting	d 0.0
	Setting range	d 0.0<->d 50.0%	Unit 0.1%

Wobble amplitude shall be calculated according to Parameter A-06.

A-08	Wobble frequency hopping(Relative aptitude)	Factory setting	d 0.0
	Setting range	d 0.0<->d 50%	Unit
			0.1%

When it is set to 0, it refers that no frequency hopping occurs.

A-09	Wobble frequency cycle	Factory setting	d 10.0
	Setting range	d 0.1<->d 655s	Unit
			0.1s

This parameter sets time for a complete work cycle including wobble rising and descending. Never select auto acceleration/deceleration running cycle in wobble frequency running mode, otherwise fault on wobble frequency cycle may occur.

A-10	Triangle wave rising time (Relative cycle)	Factory setting	d 50.0
	Setting range	d 0.1<->d 99.9%	Unit
			0.1%

This parameter sets operation time of wobble frequency rising, which is equivalent to $(A-09) \times (A-10)$ (sec), and operation time of wobble frequency rising shall be $(A-09) \times (1 - (A-10))$ (sec).

A-11	Wobble frequency machine stop starting mode	Factory setting	d 0
	Setting range	d 0	Starting in memorizing state before machine stop
		d 1	Restarting
A-12	Wobble state power loss memory	Factory setting	d 0
	Setting range	d 0	Memorizing
		d 1	Non-memorizing

This parameter shall only be available when A-11 is set to d 0 (Starting in memorizing state before machine stop).

VI. TROUBLE SHOOTING

Inverter is provided with functions of warning and protection such as over voltage, low voltage and over current. Once alarm occurs, protection function shall act, inverter output stops, alarm contactor act and also free running of motor shall stop. For causes and corrective measures of alarm, display of alarm shall be taken for reference. Alarm records shall be stored into computer memory inside AC motor drive (alarm records for recent six times shall be available), and records shall be read at digital control keypad.

Attention shall be paid that, depressing RESET after alarm shall only be available after alarm has been eliminated.

1. ALARM AND CORRECTIVE MEASURES

Display	Descriptions of fault	Corrective measures
OC	Inverter detects Over current at output side.	<ol style="list-style-type: none"> 1. Check rated current of motor complies with that of inverter. 2. Check that there is no short circuit in U, V, and W. 3. Check that no short circuit or grounding occur to connection of motor. 4. Check that screws are securely tightened to AC motor drive. 5. Increase acceleration time (1-09, 1-11). 6. Check there is no over load to motor.
OV	Inverter detects Over voltage at DC high voltage side.	<ol style="list-style-type: none"> 1. Check input voltage is within rated voltage range of inverter, and see that no voltage surge occurs. 2. If over voltage occurs at DC high voltage side of inverter caused by inertia back up voltage, deceleration time shall be increased.
OH	Inverter detects over heat, exceeding protection level.	<ol style="list-style-type: none"> 1. Check that ambient environment is not over heat. 2. Check radiator and air fan is running. 3. Check enough clearance for air flowing is provided to inverter is with.
LU	DC high voltage side over low inside inverter.	<ol style="list-style-type: none"> 1. Check power supply voltage is correct. 2. Check no sudden heavy load.
OL	Output current exceeds allowable current of inverter. 60 sec shall be in station if 150% of rated current of AC motor drive is output.	<ol style="list-style-type: none"> 1. Check motor over load. 2. Increase output capacity of AC motor drive.
OL1	Inner electric relay protection acts	<ol style="list-style-type: none"> 1. Check motor over load. 2. Check rated current (7-00) of motor is proper. 3. Check electric relay function setting 4. Increase motor capacity.
OL2	Motor load overlarge	<ol style="list-style-type: none"> 1. Check motor load is not overlarge. 2. Check over-torque detection level setting (6-03).

Display	Descriptions of fault	Corrective measures
EF	Inverter stops output when external multifunction terminals (EF) and DCM (NPN mode) closed.	Depress RESET key after alarm eliminated.
cF1	Inner memory IC data writing alarm	<ol style="list-style-type: none"> 1. Supply power again after power off. 2. Factory maintenance and overhaul.
cF2	Inner memory IC data reading alarm	<ol style="list-style-type: none"> 1. Depress RESET key and reset parameter to factory setting. 2. If step 1 unavailable, search for factory maintenance and overhaul.
cF3.1	Internal temperature is over high at power-on test	<ol style="list-style-type: none"> 1. Check the environment temperature, whether it is too high 2. If the environment temperature is normal, send to factory for service
cF3.2	Over voltage of inverter internal DC voltage side at power-on test	<ol style="list-style-type: none"> 1. Check the input voltage, whether it is within the rated input voltage of inverter. 2. If the input voltage is normal, send to factory for service.
cF3.3	Under voltage of inverter internal DC voltage side at power-on test	<ol style="list-style-type: none"> 1. Check whether the input power supply voltage is normal. 2. If the input voltage is normal, send to factory for service.
HPF.1	Circuit fault of over voltage protection	Factory service
HPF.3	Circuit fault of over current protection	Factory service
bb	Inverter stops output when external multifunction terminals and DCM (NPN mode) closed.	"bb" shall disappear immediately after signal source eliminated.
CE--	Communications alarm	<ol style="list-style-type: none"> 1. Check the connection condition of communications circuit. 2. Check the communications format.
Errb	Wobble frequency setting alarm, the central frequency of wobble frequency is lower than width, or the Max. value of wobble frequency exceeds the upper and lower limit of frequency.	<ol style="list-style-type: none"> 1. Reset the correct wobble frequency parameter.

2.TROUBLESHOOTING FOR ALARMS IN GENERAL

Alarm	Check points	Treatment
Motor doesn't run	Check connection of power supply to terminals L1/R, L2/S, L3/T?	Input power supply Supply power again after power firstly interrupted. Verify voltage class of power supply Tighten screws for terminals
	Check voltage output from output terminals U, V, W.	Supply power again after power firstly interrupted.
	Check motor is not blocked due to load over-large	Decrease load to make motor running available
	Check alarm of inverters	Check wiring and correct it if necessary in accordance with reference for alarm.
	Check fwd/rev run reference achieved	
	Check input of Analog frequency setting	Verify wiring for analog frequency input signal Verify frequency input set voltage
Verify operation mode setting	Controlled by digital operator.	
Contrary rotation direction of motor	Check wiring for output terminals U, V, W	Match correctly with terminals U, V, W of motor
	Check wiring for FWD/REV run	Verify wiring and correct if necessary
Velocity variation unavailable for motor running	Check wiring for analog frequency input	Verify wiring and correct if necessary
	Check operation mode setting	Check and verify panel operation mode setting
	Check motor is free from overload.	Decrease load
Motor running speed over high or over low	Check specification(number of poles and voltage)of motor	Confirm specification of motor
	Check gear proportion	Confirm gear proportion
	Check Max output frequency setting	Confirm Max. output frequency setting
	Check voltage is not dropping at motor side	Verify V/f curve setting
Speed variation fault during motor running	Check motor overload	Decrease load
	Check load is not in sharp variation	Decrease load variation Increase capacity of inverter and motor.
	Check no phase failure occur to power supply	For single phase mode, fix AC reactor to power supply side Verify wiring for Three phase mode.

VII. MAINTENANCE AND AMBIENT ELEMENTS

For safety and normal operation, the inverter shall be provided with daily as well as periodical maintenance.

Diagram below shows items that must be checked.

Check shall perform again after the inverter is powered off for several minutes, to prevent injury to operators caused by residual power of inverter condenser.

Inspection item	Inspection content	Inspection period		Inspection method	Assessment base	Corrective measures to fault
		Daly	Annual			
Inverter ambient environment	Verify ambient temperature and humidity	Yes		Measure with temperature or humidity meter in accordance with notes for installation	Temperature: -10 to 40℃; humidity: below 90%RH	Improve environments
	Check stacking with inflammable materials	Yes		View inspection	No foreign materials	
Inverter installing and grounding	Check abnormal vibration to machine	Yes		View and auditory inspection	No foreign materials	Tighten securing screws
	Check grounding resistance complies with specification		Yes	Measure resistance with universal meter	200V Class: below 100Ω; 400V Class: below 10Ω	Modify grounding
Input power supply voltage	Check main circuit voltage	Yes		Measure voltage with universal meter	Voltage value complies with specifications	Modify input power supply
External terminal securing screws of the inverter	Check security of screwed parts		Yes	View inspection and check screws are secured tightly with screwdriver	All OK	Tighten or sent for factory maintenance and overhaul
	Check terminal board is not damaged		Yes			
	Check no clear rust exists		Yes			
Inverter inner wiring	Check no distortion appears		Yes	View inspection	All OK	Replace or sent for factory maintenance and overhaul
	Check outer shielding is not broken		Yes	View inspection	All OK	

Inspection item	Inspection content	Inspection period		Inspection method	Assessment base	Corrective measures to fault
		Daily	Annual			
Radiator	Check no dust or chipping stacked	Yes		View inspection	All OK	Remove stacking such as dust
Printing circuit board	Check no inductive metal or oil stacked		Yes	View inspection	All OK	Remove or replace electric board
	Check elements are exclusive of color changing or burning due to overheat		Yes			
Cooling fan	Check abnormal vibration or noise		Yes	View inspection and auditory inspection	All OK	Replace cooling fan
	Check no dust or chipping stacked	Yes		View inspection		Remove
Power elements	Check no dust or chipping stacked		Yes	View inspection	All OK	Remove
	Check resistance between terminals		Yes	Check using universal meter	No short circuit or circuit break for three phase output	Replace power elements or inverter
Condenser	Check for odor or leakage	Yes		View inspection	All OK	Replace condenser or inverter
	Check for expansion or distortion	Yes				

Always inspection and maintenance is not necessary for the inverter.

For long time safety operation, periodical inspection shall be prepared to the inverter in accordance with descriptions below. Inspection shall only perform after power supply is off for several minutes. (since residual voltage may exist in the large capacity condensers.)

(1)Remove dirty stacking inside the machine

(2)Check screws securing terminals or elements are securely tightened; if not, tighten the screws